

# TRENDY SPORT®



BAMUSTA® CORTICA



CATALOG 2025

# INDEX

## MATS 4

ProfiGymMat®	6
ProfiGymMat® Professional	8
TheraMat Professional	10
RehaMat Professional	11
Fitness mats accessories	12

## BALANCE 16

Balance ball Trendy Meia	18
Gymnastic ball Bureba® Professional	20
Gymnastic balls accesories	22
Balance cushion Bamusta® Coxim	24
Bamusta® Coxim cover	27
Bamusta® Coxim XXL	28
Balance pads Bamusta Cuatro	30
Balance pads Trendy Ponte	32
Bamusta® Balance Boards	34

## FITNESS 38

Stepper Etapa	40
Suspension trainer Lacada	42
Swing stick Chicote	44
Ab wheel Bariga	46

## FASCIA 48

Massage rolls Marola & Prego	50
Hand massage rolls Pontia & Ondas	52
Fascia roll Lua	54
Fascia roll Lua Mini	56
Fascia ball Bola	58
Fascia duo ball Dupla	60
Massage ball Spiky Ball	62

## CORK LINE 64

Cork Fascia roll Cortica	66
Cork Fascia ball	68
Cork Facia duo ball	70
Cork Fascia set	71
Cork Yoga mat Cortica	72
Cork Yoga block	74
<b>NEW</b> Cork Bamusta® Boards	76

## YOGA 78

Yoga mat Professional	80
<b>NEW</b> Yoga mat Ecoline	82
Yoga belt	84
Yoga block	88
Yoga wheel Roda	92
Yoga swing Impulso	94

## PILATES 96

Pilates ring Panelo	98
Pilates ball Melina	99
Pilates roll	100

## LOOPS & TUBES 102

Hip Loops	104
Tone Loops	106
Trendy Rubber Band	108
Limite Band	110
Premium Power Sleeve	112
Premium Gym Tube	115

## ATS LINE 116

ATS® Curl bar	118
ATS® Training bar	120
ATS® Premium bar	122
ATS® Triceps Trainer	124
ATS® Squat Hex Bar	125
ATS® Barbells storage	126
ATS® accessories	128
ATS® PU Disks	130
ATS® Premium Bumper Plates	132
ATS® Drop pads	136
ATS® Weight sled	138
ATS® Plyo Box	140
ATS® Pull up rack	142

## WEIGHTS 144

Body Bar Pesos	146
Pump Set TS	148
Pesos Aperto Pump Set	150
<b>NEW</b> Hex dumbbells	152

Chrome dumbbells	156
Vinyl dumbbells	158
Kettlebells Black	160
Kettlebells Vinyl	161
Esfera Slam balls	162
<b>NEW</b> Esfera weight bag	164
Weight cuffs	166

## FLOORING MATS 168

Rubber flooring Segura Interlocking	170
Rubber flooring Segura	172
Rubber flooring Segura farbig	174
Rubber flooring Segura Absorption	178
Cardio flooring Fundamento	180
<b>NEW</b> Sprint track	182
<b>NEW</b> StudioLine Classico	184
StudioLine Madeira	185
Double Competition Standard	186
Double Competition Profi	187
Double Competition Judo	188

## RFID PRODUCTS 190

RFID wristband	192
RFID wristband CleverFit	194
RFID card	196
RFID tag	197

# MATS



PLEASE CLICK DIRECTLY  
TO THE PRODUCT!

ProfiGymMat® .....	6
ProfiGymMat® Professional .....	8
TheraMat Professional .....	10
RehaMat Professional .....	11
Accessories .....	12



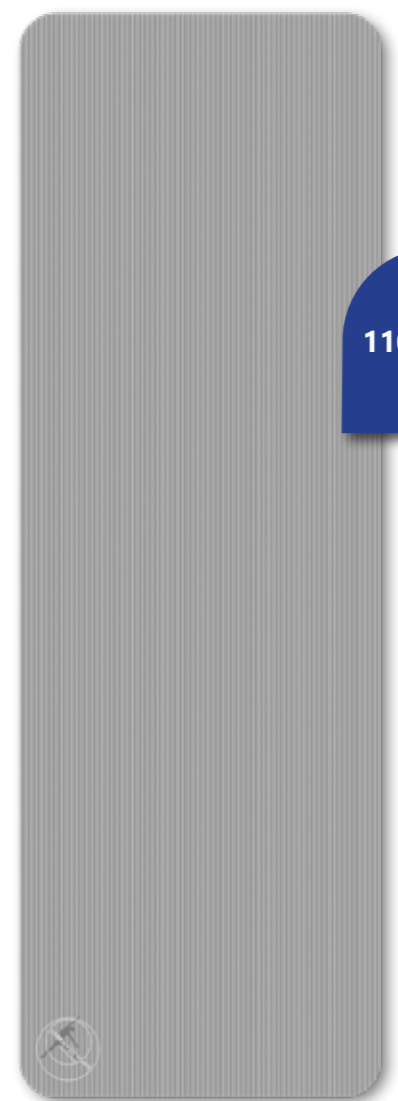
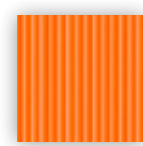
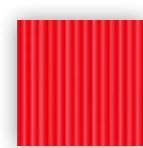
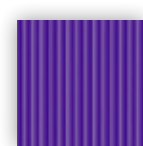
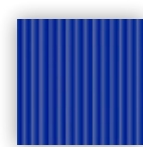

▶ MORE DETAILS

**ProfiGymMat®**

180 x 60 cm,  
Density 110 Kg/m<sup>3</sup>  
Material: NBR

Like all of our ProfiGymMats, this gym mat consists of the soft and stable NBR foam. With a density of 110 Kg/m<sup>3</sup>, this ProfiGymMat is the softer version and is used particularly in the private sector. The food-safe material is characterized by its mechanical resistance and is therefore extremely durable. The mat is BPA-free and therefore suitable for pregnancy exercises and fitness with children.

Colour/Thickness	1 cm	1,5 cm
Grey	8204GR	8205GR
Anthracite	8204A	8205A
Blue	8204B	8205B
Purple	8204P	8205P
Red	8204R	8205R
Orange	8204OR	8205OR

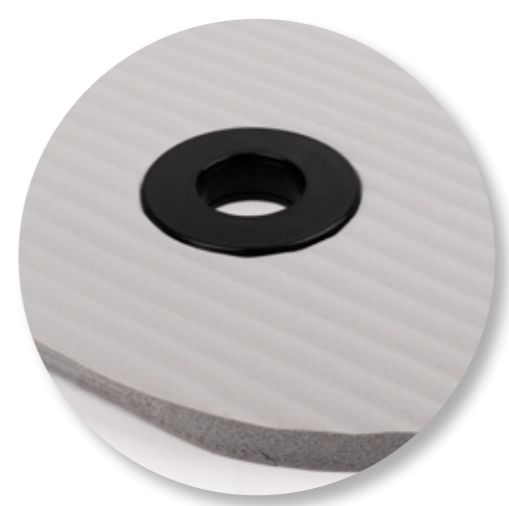

**ProfiGymMat® with eyelet**

180 x 60 cm  
Density 110 Kg/m<sup>3</sup>  
Material: NBR

The ProfiGymMat® is also available with eyelets in the same quality but with a limited colour selection.

The mats can be customized with UV printing upon request.

Colour/Thickness	1 cm	1,5 cm
Grey	8124GR	8125GR
Anthracite	8124A	8235A
Blue	8124B	8125B

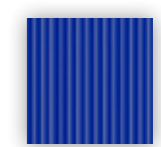
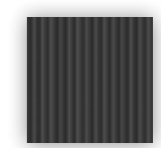
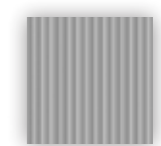

- resilient
- tear-resistant
- dimensionally stable
- easy adaptation
- comfortable and flexible
- antibacterial protection
- easy to clean with water

closed cell structure

antibacterial protection

optimal absorption

customizable

durable

harmless



▶ MORE DETAILS

**ProfiGymMat® Professional**

Length 120 / 140 / 180 / 190  
Density 170 Kg/m<sup>3</sup>  
Material: NBR

The ProfiGymMat® Professional is extremely robust with a material density of 170 kg/m<sup>3</sup>. Due to the new vertical structure, the mat wears less. This makes them even more comfortable and increases their durability at the same time. The mat is BPA-free and therefore suitable for pregnancy exer-

cises and fitness with children. The quality of the new generation of ProfiGymMat® Professional speaks for itself and meets the highest demands in all professional areas. The mats can be customized with UV printing upon request.

- closed cell structure
- antibacterial protection
- optimal absorption
- customizable
- durable
- harmless

Colour/Size	120 x 60 x 1 cm	140 x 60 x 1 cm	140 x 60 x 1,5 cm	180 x 60 x 1 cm	180 x 60 x 1,5 cm	190 x 80 x 1,5 cm
Grey	8016GR	8001GR	8002GR	8004GR	8005GR	8011GR
Anthracite	8016A	8001A	8002A	8004A	8005A	8011A
Blue	8016B	8001B	8002B	8004B	8005B	8011B
Red	8016R	8001R	8002R	8004R	8005R	8011R
Purple		8001P		8004P	8005P	
Orange		8001OR		8004OR	8005OR	
Green		8001G	8002G	8004G	8005G	

**ProfiGymMat® Professional with eyelets**

Length 120 / 140 / 180 / 190  
Density 170 Kg/m<sup>3</sup>  
Material: NBR

The ProfiGymMat® Professional is also available with our own designed high quality eyelets.

- resistant and stable in shape
- tensile strength
- comfortable, flexible and flat lying
- easy rolling and unrolling
- no sticking-out corners
- optimum shock absorbing
- both sides usable, in the studio, outdoor and in water
- super hygienic
- closed cellular structure
- anti-germ protection
- hydrophobic and dirt-repellent
- easily cleanable with water

eyelet system made in Germany

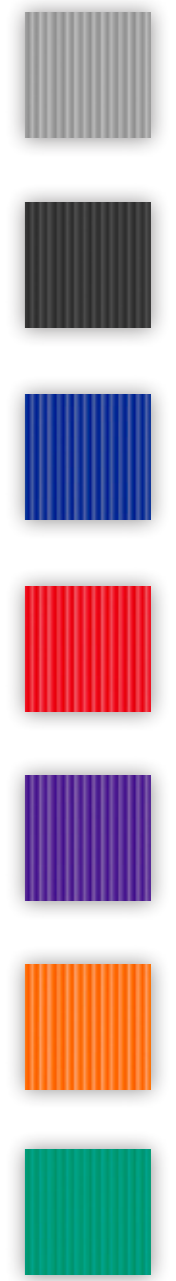
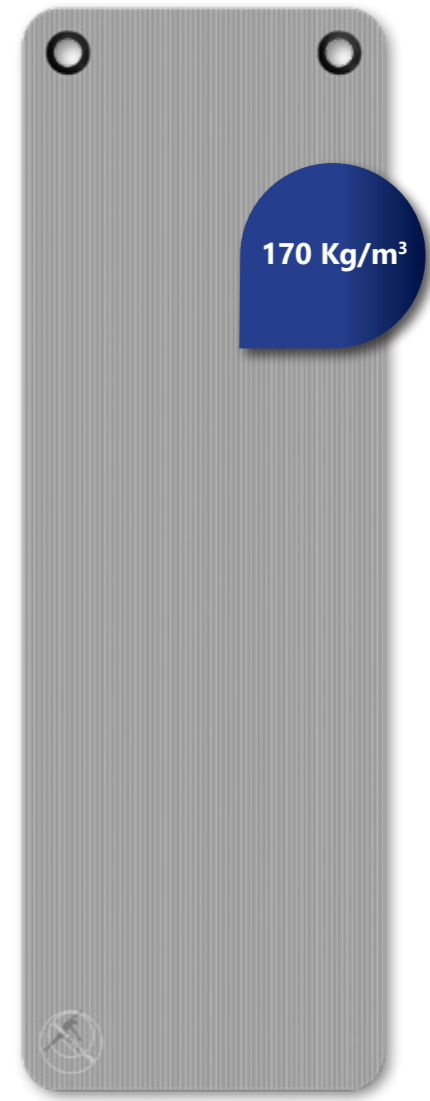

Colour/Size	120 x 60 x 1 cm	140 x 60 x 1 cm	140 x 60 x 1,5 cm	180 x 60 x 1 cm	180 x 60 x 1,5 cm	190 x 80 x 1,5 cm
Grey	8116GR	8101GR	8102GR	8104GR	8105GR	8111GR
Anthracite	8116A	8101A	8102A	8104A	8105A	8111A
Blue	8116B	8101B	8102B	8104B	8105B	8111B
Red	8116R	8101R	8102R	8104R	8105R	8111R
Purple		8101P		8104P	8105P	
Orange		8101OR		8104OR	8105OR	
Green		8101G	8102G	8104G	8105G	



▶ MORE DETAILS

### TheraMat Professional

180 x 120 x 1,5 cm  
Density 170 Kg/m<sup>3</sup>  
Material: NBR

optional  
with eyelets  
available

- closed cell structure
- antibacterial protection
- optimal absorption
- durable
- BPA FREE

The luxury variant of the ProfiGym-Mat is called TheraMat Professional. In addition to the therapy, the rehabilitation area is also an area of application. The TheraMat impresses by its size: 180 cm x 120 cm in thicknesses 1,5 cm. With this measurements it is indispensable in the therapeutic field. Self-exercises lateral roll movements are no problem.

Of course the TheraMat has all the advantages of the ProfiGymMat®. Also available including eyelets.

Colour/Size	without eyelets	with eyelets
Grey	8007GR	8107GR
Anthracite	8007A	8107A
Blue	8007B	8107B
Red	8007R	8107R
Green	8007G	8107G

**NEU**  
now also in grey  
and anthracite  
available!

▶ MORE DETAILS

### RehaMat Professional

200 x 100 x 2,5 cm  
Density 170 Kg/m<sup>3</sup>  
Material: NBR

- closed cell structure
- antibacterial protection
- optimal absorption
- durable
- BPA FREE

The new RehaMat Professional is matched to the highest demands in the rehabilitation sector. Due to its shape with straight edges, it is perfectly suited for assembling several mats for group therapy. With a thickness of 2,5 cm the RehaMat Professional provides the right foundation for demanding exercises.

Of course the RehaMat Professional has all the advantages of the ProfiGymMat® Professional.

Colour	Article
Grey	8009GR
Anthracite	8009A
Red	8009R
Blue	8009B

**NEW**  
now also in grey  
available!



▶ MORE DETAILS 

**Mount metal**

ca. 80 x 10 cm  
Eyelet distance variable, max. ca. 70 cm  
Material: Steel, coated

Our variable mount metal is an individually adjustable wall suspension for all kind of mats with max. eyelet distance of ca. 70 cm.

The product is now available in silver or anthracite.

Article	Art. No.
Anthracite	8108
Silvergrey	8108SG

max. capacity

- ProfiGymMat 1 cm: 15 pcs.
- ProfiGymmat 1,5 cm: 10 pcs.
- Trendy YogaMat 0,5 cm: 20 pcs
- Max. weight 15 Kg

new colour!

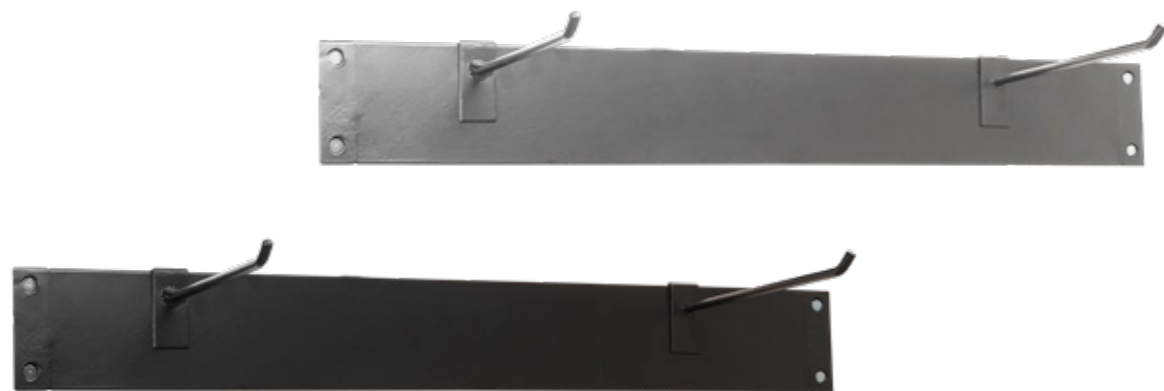

NEW  
now available



▶ MORE DETAILS 

**Mat cart Carro**

83 x 77 x 207 cm (L x W x H)  
Eyelet distance variable  
Material: Steel

We have equipped our new Carro mat cart with even more additional functions and have been able to significantly increase the processing quality. Carro is extremely flexible and adapts perfectly to your individual requirements. The cart can now be adjusted in height between 178 - 207 cm over six levels and thus adapted to the mat size. The distance between the eyelets can be continuously adjusted on both sides up to a maximum of 59 cm. Carro is therefore suitable for all commercially available mats with eyelets.







Article	8106
---------	------

max. capacity

- ProfiGymMat 1 cm: 30 pcs.
- ProfiGymmat 1,5 cm: 20 pcs.
- Trendy YogaMat 0,5 cm: 40 pcs.
- Max. weight 15 Kg each side



-  closed cell structure
-  antibacterial protection
-  optimal absorption
-  durable
-  harmless

▶ MORE DETAILS 

**Carry Bag**

83 x Ø 20 cm  
Material: PU

The carrying bag for ProfiGymmats® size 120 - 140 - 180 not only guarantees you space-saving and protected storage, but also makes the mat comfortable to carry. In addition, the mat on the side wall of the bag is easier to remove.

Article 8110



▶ MORE DETAILS 

**Velcro Standard**

Material: PP

With the help of the velcro tape, you can now hold your ProfiGym-Mat® particularly easily and therefore also transport it. They have a length of 78 cm.



Article 8013



▶ MORE DETAILS 

**Velcro Profi**

Material: PP

With the help of the velcro tape, you can now hold your ProfiGym-Mat® particularly easily together. In addition, the connection between the two velcro straps guarantees easy transport.

Article 8014



# BALANCE



PLEASE CLICK DIRECTLY TO THE PRODUCT!

- Trendy Meia ..... 18
- Gymnastic ball Bureba Professional ..... 20
- Gymnastic ball accessories..... 22
- Balance cushion Bamusta Coxim ..... 24
- Balance cushion Bamusta Coxim XXL ..... 28
- Balance pads Bamusta Cuatro ..... 30
- Balance pads Trendy Ponte ..... 32
- Balance pads Trendy Ponte ..... 32
- Bamusta® Balance boards..... 34



antislip surface



Perfect fit

▶ MORE DETAILS

**Trendy Meia®**

Size: Ø 63 x max. 22 cm  
Material: PVC, PP

The new Trendy Meia® is a versatile training device. It enables exercises for balance, dexterity and strengthening of the muscles. Make use of the top and bottom! The Trendy Meia® is an ideal combination of Bureba® Ball and Ba-

musta® Board. The Trendy Meia offers a non-slip and safe base for all applications. The scope of delivery includes an inflation pump and a tape measure.

Max carrying capacity 200 KG  
Incl. new sales packaging.

Colour	Article
Anthracite	9600A
Blue	9600B
Grey	9600GR



incl. pump



▶ MORE DETAILS

**Trendy Meia® Expander**

Länge: 100 cm  
Material: TPR, Nylon cover

With our new Trendy Meia® Expander you can add a useful addition to your Trendy Meia®. The expanders only have to be hooked into the rings provided on the side of the Trendy Meia® using the high-quality stainless steel carabiner. The foam grips ensure maximum comfort. This gives you even more exercise options for balance, strength and coordination with your Trendy Meia®.

Price per pair

Article	9611
---------	------





**NEW**  
now available

**BURST RESISTANT BALL**

**Bureba® Ball Professional**

Material: PVC 6P free

The Bureba® Ball Professional can be used both as a training device and as a sitting ball. The exercise ball meets extremely high safety requirements. The carrying capacity is 300 kg and thanks to the burst system, the ball cannot burst even if it is damaged with sharp objects. The Bureba® Professional is available in three sizes and four colours as well as transparent and can be inflated and regulated individually with each pump.

Max. carrying capacity 300 kg  
Burst resistant up to 100 kg  
Incl. sales packaging  
Including pump

▶ MORE DETAILS

antibacterial protection  
 durable  
 recyclable  
 6P FREE

Colour/Size	Ø 55 cm	Ø 65 cm	Ø 75 cm
Anthracite	7030A	7040A	7050A
Blue	7030B	7040B	7050B
Red	7030R	7040R	7050R
Grey	7030SG	7040SG	7050SG



▶ MORE DETAILS

**Bureba® Ball cover**

Size: ca. Ø 65 cm

washable  
 durable

Complement your Bureba exercise ball with our soft and neutral deaf fabric cover. This is easy to attach with a zipper and can be removed at any time and washed hygienically at 30°. A handle makes it easy to hold and transport the ball and a rubber ring on the underside of the cover ensures that the ball cannot roll away.

The exercise ball is transformed into beautiful furniture and offers even more comfort for your home office, physiotherapy, fitness or yoga studio. Incl. sales packaging.

Article 7211

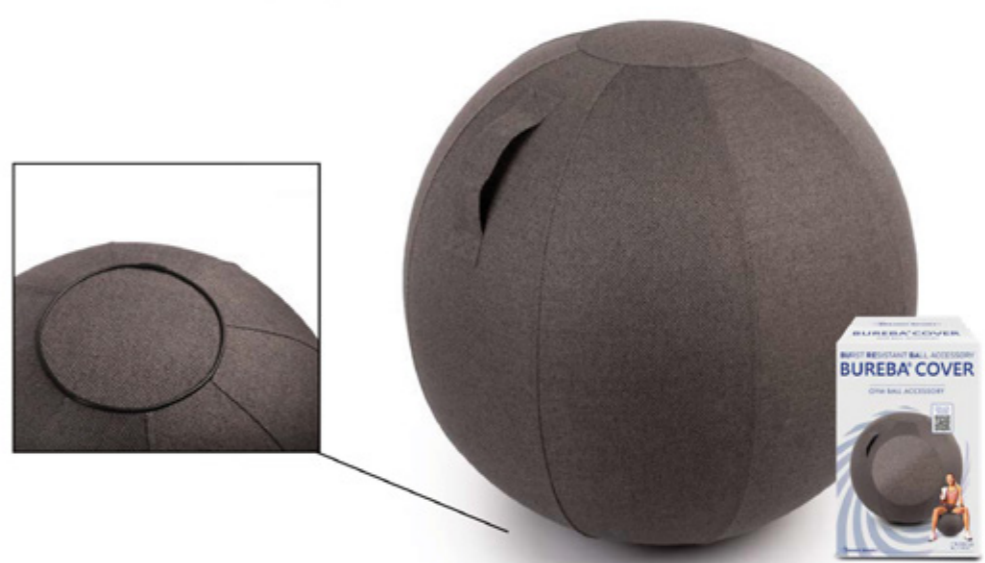



▶ MORE DETAILS



**2 channel Hand pump**

With this hand pump you can easily inflate each of our seat balls. Thanks to the double stroke function, the ball can now be inflated even faster.



Article 6021

▶ MORE DETAILS



**Ball bowl**



Ø 45 cm

Thanks to the ball cup, your sitting ball stays in the desired position and cannot roll away. The ball cup is suitable for all seating ball sizes.

Article 6022

▶ MORE DETAILS



**Bureba® Stacking system**

Size: 10 cm x Ø 31 cm  
Material: PMMA



With the Bureba stacking system, several Bureba® balls can be stacked on top of each other to save space.

Article 6024



▶ MORE DETAILS



**Bureba® Rack**

For 10 Bureba® 55 cm  
Hight 195 x Ø 100 cm  
Material: Steel, coated

Article 6023



▶ MORE DETAILS 

**Bamusta® Coxim**

Ø 33 cm  
Material: PVC 6P free

With its air cushion, the Bamusta® Coxim very comfortably transmits all movements. The special feature here is the air regulation by means of a needle valve thus the air level in the pillow can be adjusted individually. The seat cushion consists of two smooth sides.

incl.  
pump



This product not only trains the back muscles and promotes an upright sitting position, but also achieves a new form of sitting. Of course, the Bamusta® Coxim can also be integrated into a training session in order to achieve more body tension and balance.

Max. carrying capacity 300 kg  
Incl. sales packaging  
Pump included

Colour	Article
Anthracite	9191A
Blue	9191B
Rred	9191R
Grey	9191GR



The seat cushion can be customized with a sticker upon request.



**NEW**  
cover now available

▶ MORE DETAILS 

**Bamusta® Coxim with knops**

Ø 33 cm  
Material: PVC 6P free

The seat cushion is also available with a smooth and a nubby side. The decision whether to sit on the smooth or nubby side of the seat cushion is also up to the user and offers an even wider range of training options.

The seat cushion can be customized with a sticker upon request.

Max. carrying capacity 300 kg  
Incl. sales packaging  
Pump included

Colour	Article
Anthracite	9190A
Blue	9190B
Red	9190R
Grey	9190GR

Incl. pump



▶ MORE DETAILS 

**Bamusta® Coxim cover**

Ø 33 cm

The Bamusta Coxim cover is a practical accessory for our Bamusta Coxim seat cushion and fits both the version with and without nubs. The cover can be opened via the zipper and easily pulled on. The cover can also be washed at 30° and is therefore particularly hygienic. Incl. sales packaging.



Article	9192
---------	------





**NOW**  
improved  
quality!



incl.  
pump



▶ MORE DETAILS 

**Bamusta® Coxim XXL with knops**

Ø 60 cm  
Material: PVC 6P free

With its air cushion, the new 60 cm Bamusta® Coxim XXL very comfortably transmits all movements. The special thing here is the air regulation by means of a needle valve, so that you can adjust the air level in the pillow as you like. This product with a smooth and a nubby side not only trains the back muscles and promotes an upright sitting posture, but also achieves

a new form of sitting and balance. Of course, the Bamusta® Coxim XXL can also be integrated into a training session in order to achieve more body tension and balance.  
  
Max. carrying capacity 300 kg  
Incl. sales packaging  
Pump included



-  antibacterial protection
-  durable
-  recyclable
-  6P FREE

Colour	Article
Anthracite	9094A
Blue	9094B
Grey	9094GR

%%  
Stock sale  
%%

▶ MORE DETAILS 

**Bamusta® Cuatro XL**

48 x 48 x 6 cm  
Material: TPE

The square Bamusta® Cuatro XL is made of 60 mm thick closed-cell foam and impresses with its excellent damping properties, even with punctual loads, is also non-slip due to the waffle structure, water-repellent and easy to clean. The 100% recyclable material is free of PVC and plasticizers and therefore particularly skin-friendly.

Max. carrying capacity 300 kg  
Incl. sales packaging.



Colour	Article
Anthracite	9000AXL
Blue	9000BXL

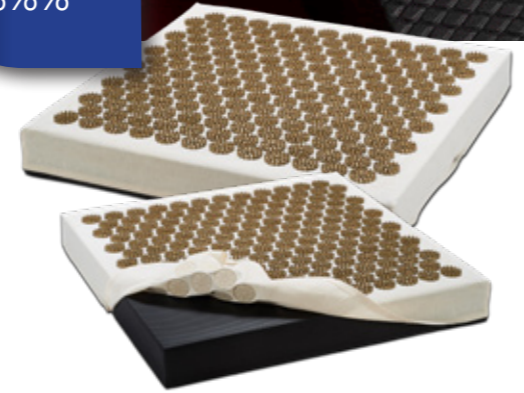
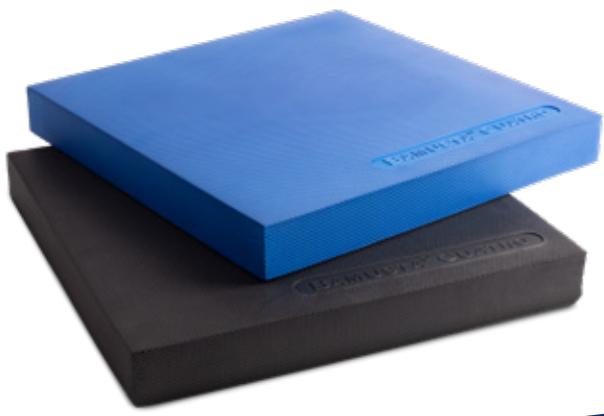

▶ MORE DETAILS 

**AcuReWell®  
Acupressure cover Picata  
for Bamusta Cuatro XL**

48 x 48 cm  
Material: 100% cotton  
ABS (akupressure points)

This acupressure cover with 168 massage points fits perfectly on our Bamusta® Cuatro XL balance pad and thus expands its range of functions in a space-saving manner. An elastic band on the back ensures that the cover cannot slip.

Article	9423N
---------	-------



antislip  
surface

▶ MORE DETAILS 

**Bamusta® Cuatro**

48 x 38 x 6 cm  
Material: TPE

The quadrangular Bamusta® Cuatro is made from 60mm thick closed cellular foam material with the same excellent product characteristics as the Bamusta® Cuatro XL.

Max. carrying capacity 300 kg  
Incl. sales packaging.

-   
closed cell structure
-   
antibacterial protection
-   
optimal absorption
-   
light weight
-   
allergy friendly
-   
100% recyclable
-   
free of softener

Colour	Article
Anthracite	9000A
Grey	9000GR
Blue	9000B
Red	9000R







▶ MORE DETAILS 

**Trendy Ponte**

Size: 31 x 29 x 9,5 cm  
Material: EVA



Trendy Ponte offers you through its two sides a very extensive spectrum of possible uses. With the help of the pointed elevations and the depression in the middle, the board can be used particularly well for fascia training.

Above all, the supine position, in which pressure is created by lowering the pelvis, is particularly effective in mobilizing, stretching and strengthening the lower back.

Not only can the trigger points be determined individually, but a massage effect can also be created.

Incl. sales packaging.

Article 9117



The effects can also be felt during fascia training while standing, as the foot is mobilized and the balance is strengthened. In addition, the calf is stretched, the foot lift and balance are trained. The Trendy Ponte is not only suitable for fascia training, but also for the fitness area. It can be used as a rocker crosswise or lengthways to bring yourself off balance through conscious movements. A particular success is achieved in the areas of stabilization, balance and stretching.



2 in 1



▶ MORE DETAILS   YouTube

**Bamusta® Placa**

60 x 39 x 10 cm  
Material: EVA, Plywood

With its four non-slip corner feet, the Bamusta® Placa has a safe and solid contact to the ground. The flexible feet create a gentle but challenging coordination of movements. It is ideal for the early build-up of muscles.

Max. carrying capacity 150 Kg  
Incl. sales packaging.

Article 9007A



▶ MORE DETAILS   YouTube

**Bamusta® Circulo**

Ø 39 x 11 cm  
Material: EVA, Plywood

challenging metatarsus



With its center foot the Bamusta® Circulo encourages a highly challenging mobility coordination in the advanced use and is ideal for the continuous build-up of muscles. A round surface with a large center foot creates unstable tilting movements.

Max. carrying capacity 150 KG.  
Incl. sales packaging.

Article 9009A



▶ MORE DETAILS 

 YouTube

**Bamusta® Tablero**

60 x 39 x 13 cm  
Material: EVA, Plywood

With its high center foot the Bamusta® Tablero encourages an even higher challenging mobility coordination in the ambitious use and is ideal for the continuous build-up of muscles. The large surface allows a variety of positions for foot, hand and sitting.

Article 9008A

With this board you achieve an optimal balance, coordination, mobility and a good physical condition for sports. Fit with the balance-kick!

Max. carrying capacity 150 KG.  
Incl. sales packaging.



closed cell structure



durable





▶ MORE DETAILS 

**Bamusta® Dois**

Ø 42,5 x 8 / 5,5 cm  
Material: PP



The special thing about Bamusta® Dois Board is that you have two boards in one, because to make the exercise easier in seconds, you just have to remove the foot on the underside of the board, which in turn changes the load. Here you not only train your balance, coordination and flexibility, but also your body control.

Max carrying capacity 200 KG  
Incl. new sales packaging.

Article 9092



2 in 1

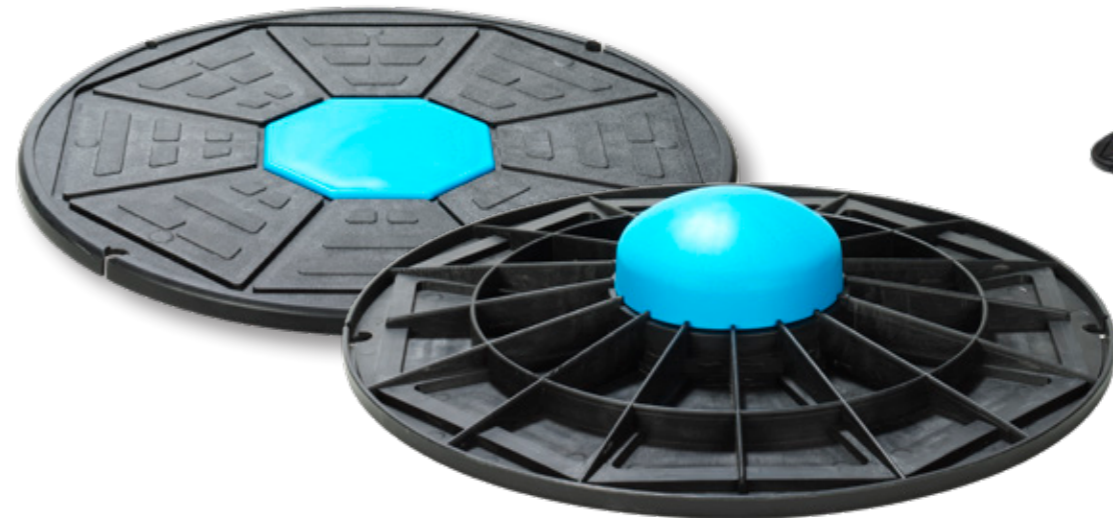

# FITNESS



PLEASE CLICK DIRECTLY  
TO THE PRODUCT!

Stepper Etapa .....	40
Suspension Trainer Lacada .....	42
Swing Stick Chicote .....	44
Ab wheel Bariga .....	46

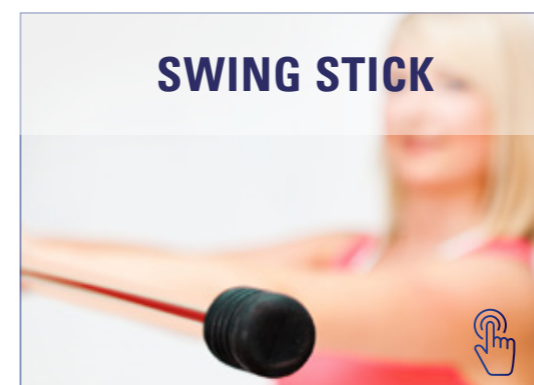

# TRENDY ETAPA

In 2 colours available

▶ MORE DETAILS 

## Stepper Etapa

90 x 35 cm / Weight 7,5 KG  
Material: PP, TPE, ABS

Trendy Etapa Professional gives you that extra kick for your full body workout. Train your legs, abs, back, arms and shoulders and improve your coordination and condition! The stepper is particularly easy to adjust in 3 heights, so that you can choose between a height of 15 cm, 20 cm or 25 cm depending on your

fitness level or exercise. The non-slip surface and the rubber feet also guarantee a firm and secure footing on the stepper. The stepper is available with gray or red feet. The inlay can be individualized on request.

Max. carrying capacity 200 kg

- compact and stackable design
- easy height adjustment
- non-slip surface
- 3 adjustable heights: 15, 20 and 25 cm
- spare parts available

Colour	Article
Grey	9095
Red	9095R



Triple height adjustment - 15, 20 or 25 cm



## Etapa Blocks

Article	9095U
---------	-------

## Etapa Feet

Article	9095F
---------	-------



## Etapa Clips

Article	9095C
---------	-------





▶ MORE DETAILS

**Trendy Lacada**

Max. 260 x 38 cm  
 Material: Nylon (strap), stainless steel (carabiner), Neoprene (pad in foot sleep)



The Trendy Lacada suspension trainer is a full-body training device for fitness, physiotherapy or home training which, with the help of your own body weight and high body tension, addresses all muscle groups extremely effectively and trains strength, coordination and flexibility.

With variable leverage and height settings, Lacada offers a very large selection of exercises while standing, sitting or lying down. Lacada can be attached to a ceiling suspension (not included) or, in the private sector, can also be clamped in the door frame using the supplied clamp fastening. The soft neoprene pad on the foot

straps provides additional comfort. Along with our non-slip handles, secure double seams and high-quality stainless steel carabiners we offer you a training device of the highest quality!

Article 5060



also for private areas: clamping in the door frame (included)

▶ MORE DETAILS

**Ceiling Mount**

(not included)



Article 8107

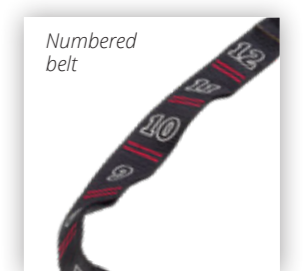



▶ MORE DETAILS 

**Chicote Rack**

For 20 Chicote  
33 x 33 x 122 cm (L x W x H)

Article	5011
---------	------



▶ MORE DETAILS 

**Swing Stick Chicote**

158 cm / Weight 0,75 KG  
Material: Fiberglass, TPR

The Chicote Swing Stick is characterized by its various uses and applications. It is particularly popular in the areas of aerobics, stabilization and rehabilitation. There is also a particularly positive effect in terms of stability, balance, muscle strength and endurance. The high quality of the rod ensures a high level of security. The handles are washable, which ensures a high level of hygiene. Benefit from the dynamics that the



antibacterial protection



durable



recyclable

Colour	Article
Anthracite	9099A
Red	9099





customizable durable recyclable



▶ MORE DETAILS 

**Ab Wheel Bariga**

25 x Ø 17 cm  
Material: Steel, PP, PVC, TPR

The Bariga abdominal roller is the ideal training accessory for even more intensive abdominal muscle training. In addition to the abdominal muscles, the back, buttocks, arm and leg muscles as well as coordination and body tension are addressed. The training device is suitable for advanced users who already have a certain body stability.

Article 9905



Thanks to its compact design, the Abr Wheel is not only suitable for the fitness area, but is also always ready for use on the go. The Ab Wheel can be easily disassembled by pulling off the rubber grip caps and stowed away even smaller. The handles offer thanks to the corrugation and the grooves a secure hold during training and that rubberized profile wheel ensures a comfortable and padded run.

Incl. sales packaging.





# FASZIA PRODUCTS



PLEASE CLICK DIRECTLY TO THE PRODUCT!

Massage rolls Marola & Prego .....	50
Hand massage rolls Pontia & Ondas .....	52
Fascia roll Lua .....	54
Fascia roll Lua Mini .....	56
Fascia ball Bola .....	58
Fascia duo ball Dupla .....	60
Spiky ball .....	62



▶ MORE DETAILS 

 YouTube

**Trendy Marola**

30 x Ø 13 cm  
Material: EVA, ABS (tube and cap)

With the help of the stable and robust surface structure of the fascia massage roll, an excellent trigger point therapy can be brought about and a complete muscle massage can be achieved. This is particularly important because the everyday stress on our body can lead to one-sided stress on the muscle and fascia tissue.

As a result, the cells store more fibers, which causes the tissue to become denser and the circulation to be restricted, so that shortened and densified muscle areas are formed, so-called trigger points.

Article 9102



▶ MORE DETAILS 

**Trendy Connector**

With the Trendy connector you can connect two Trendy Marola or Prego fascia rolls to each other and thus get a 60 cm long fascia roll for an even more diverse choice between exercises while standing, lying or sitting.

To do this, you have to unscrew a cover from the roll and screw in the connector between the two rolls.

Incl. sales packaging.



Article 9122

▶ MORE DETAILS 

**Trendy Prego**

30 x Ø 13 cm  
Material: EVA, ABS (tube and cap)

The pyramid-shaped massage points of the Trendy Prego are especially suitable for deeper lying and more firmly seated tension in the muscle areas of the lower extremities, the back and to stabilize the trunk. The gently curved center relieves the spine and at the same time provides an intensive massage of all adjacent muscle areas. Accessories such as Trendy Bola can be stored inside the roll and closed with the screw cap.

Incl. sales packaging.



-  closed cell structure
-  light weight
-  durable
-  recyclable

Article 9104





▶ MORE DETAILS YouTube

**Massage Roll Pontia**

39 x Ø 7 cm  
Material: EVA, PP (cap), POM (tube), TPR (grip)

When using the Trendy Pontia you have an active and quick regeneration of the tissue. The soft tissue components of our connective tissue are known as fascia, which span our body like a net. The fascia are also involved in important movements and metabolic processes. Due to the pyramid-shaped elevations, lower-lying fascia can also be

reached and thus resolved as a result of regular use, which in turn promotes and increases blood circulation. Thanks to the handles, the roller is stable and secure in your hands and thus also makes it easier to reach places such as the neck, legs, arms and shoulders.

The roller cover a wide range of applications and, thanks to their comfortable size, fits in any sports bag.

Incl. sales packaging.

Article 9106

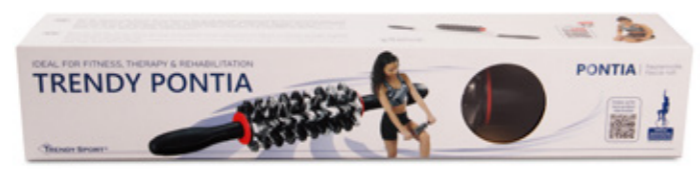

▶ MORE DETAILS

**Massage Roll Ondas**

39 x Ø 7 cm  
Material: EVA, PP (cap), POM (tube), TPR (grip)

The wave-shaped massage roller Ondas does not work as deeply into the muscles as the Pontia massage roller and acts a little more gently.

Incl. sales packaging.

Article 9107

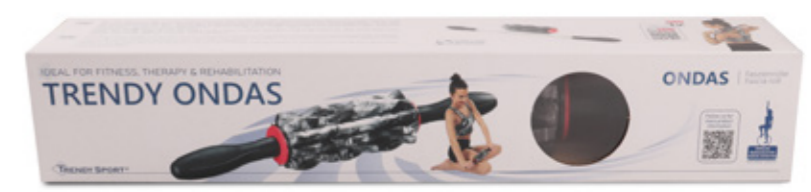

- closed cell structure
- light weight
- durable
- recyclable

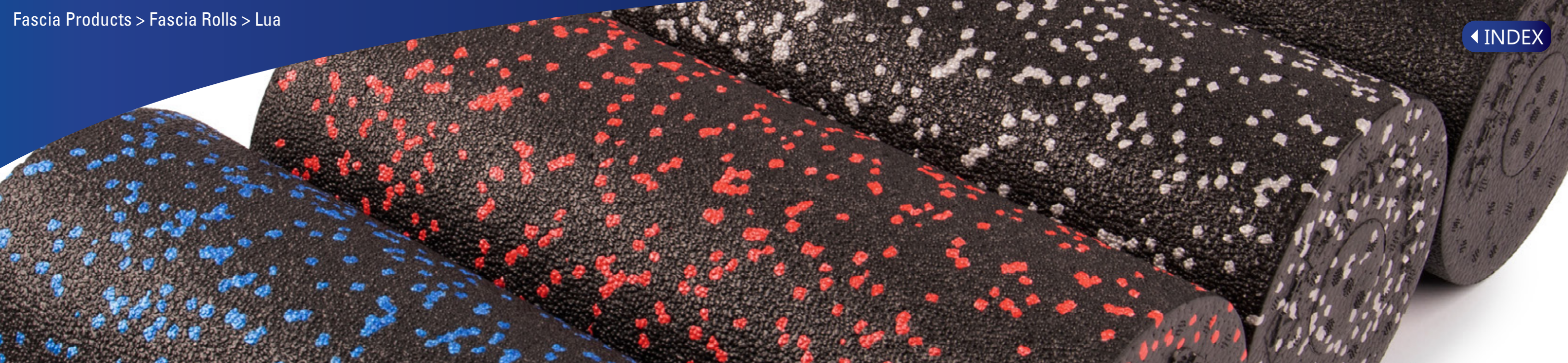

▶ MORE DETAILS 

 YouTube

**Trendy Lua**

33 x Ø 14 cm  
Weight: 350 g  
Material: EPP

The newly revised Lua fascia roll is now available in four colours and has an even smoother surface!

The smaller fascia roll can be pulled out and used for massages in hard-to-reach areas or as a connection for an extension with a second roll. The Trendy fascia roll is made of an EPP material that is very resistant and at the same time dimensionally stable.

The product can be customized with doming or laser engraving upon request.

Incl. sales packaging.



Colour	Article
Anthracite	9115A
Black/Red	9115R
Black/Blue	9115B
Black/Grey	9115GR

2 in 1 roll



-   
closed cell structure
-   
light weight
-   
customizable
-   
recyclable
-   
sustainable production

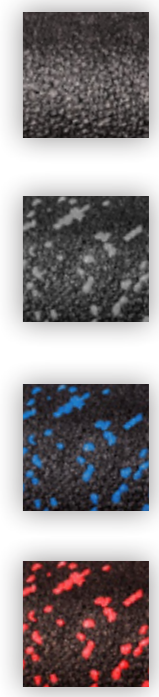

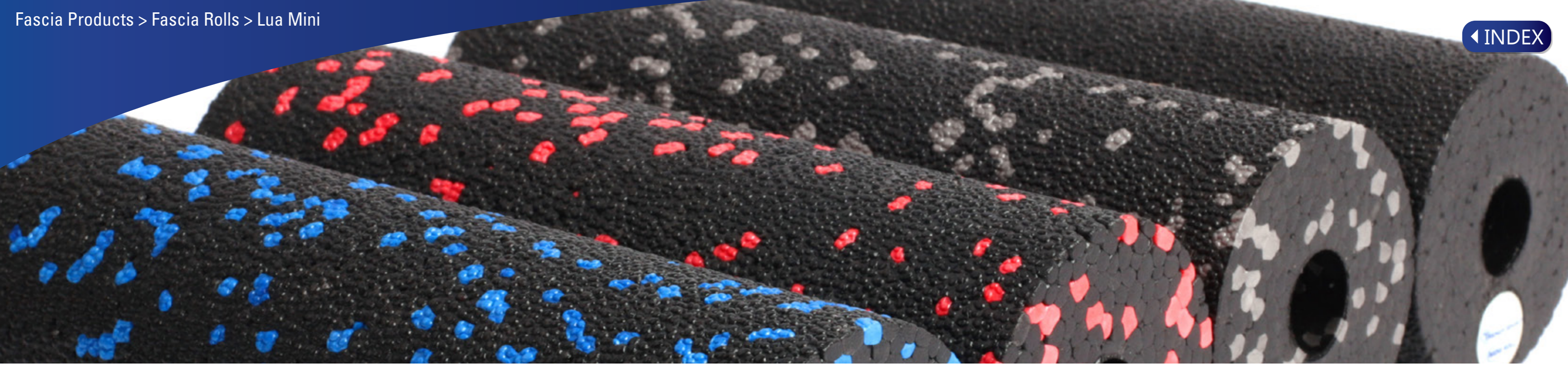

▶ MORE DETAILS

**Trendy Lua Mini**

15 x Ø 5,5 cm  
Weight: 15 g  
Material: EPP

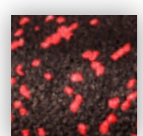
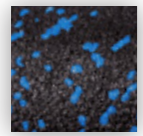
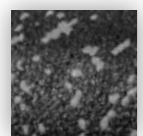

The robust Trendy Lua Mini fascia massage roll with its smooth design provides excellent trigger point therapy and a complete muscle massage. The Trendy fascia roll consists of an EPP material that is very robust and dimensionally stable.

The handy roll is also very practical on the go and can therefore be optimally integrated into everyday life.

The product can be customized with doming or laser engraving upon request.

Incl. sales packaging.



Colour	Article
Anthracite	9108A
Black/Red	9108R
Black/Blue	9108B
Black/Grey	9108GR

▶ MORE DETAILS

**Fascia Set**

Fascia roll Lua Mini  
+ Fascia ball Bola S



Our Lua Mini fascia roll is also available as a set together with the Bola S fascia ball.

The set can be customized with doming or laser engraving upon request.

Incl. sales packaging.

- closed cell structure
- light weight
- customizable
- recyclable
- sustainable production

Article	9108SA
---------	--------





▶ MORE DETAILS 

### Fascia Ball Bola

Sizes: Ø 6 cm / Ø 8 cm / Ø 10 cm  
 Weight: 7 g / 13 g / 31 g  
 Material: EPP

The fascia ball series was mainly developed for the self-treatment of trigger points and tension. With the help of the compact size even small, deeper and therefore difficult to reach tensions in fascia and muscles can be achieved. This means that trigger point therapy can be used, which is especially important today. Our body is exposed to a lot of stress every day, which is mainly due to an often unfavorable work posture, too

little exercise or too much stress. As a result unilateral stress can occur in muscle and fascia tissue causing the cells to begin storing more fibers. The consequences should not be underestimated as the tissues become denser and harder which reduces blood flow. This allows shortened and compressed muscle areas to form within a muscle, the so-called trigger points. These can spread to other parts of the

body and cause severe pain there. With the help of constant pressure and regular use of the fascia balls at these points, the tissue can be relaxed and the trigger points released. Choose the right size for your fascia ball and determine the intensity of your massage yourself!

### Fascia Ball Bola Colour

Sizes: Ø 6 cm / Ø 8 cm / Ø 10 cm  
 Material: EPP

Now the fascia ball is also available in gray, blue and red in all three sizes.

The product can be customized with doming or laser engraving upon request.

Incl. sales packaging.



Colour/Size	Bola S	Bola M	Bola L
Anthracite	9116S	9116M	9116L
Black/Red	9116SR	9116MR	9116LR
Black/Blue	9116SB	9116MB	9116LB
Black/Grey	9116SGR	9116MGR	9116LGR





closed cell structure



light weight



customizable



recyclable



sustainable production

▶ MORE DETAILS 

 YouTube

### Fascia Ball Dupla & Dupla XL

Material: EPP

The Dupla fascia ball combines two fascia balls in one and thus enables a massage of parallel muscle strands.

Now the fascia ball is also available in both sizes in red, blue and grey.

The product can be customized with doming or laser engraving upon request.



#### Trendy Dupla XL

Art. No. 9110XL  
24 x Ø 12 cm  
Weight: 140 g

#### Trendy Dupla

Art. No. 9110  
16 x Ø 8 cm  
Weight: 31 g

Colour/Size	Dupla	Dupla XL
Anthracite	9110	9110XL
Black/Red	9110R	9110XLR
Black/Blue	9110B	9110XLB
Black/Grey	9110GR	9110XLGR

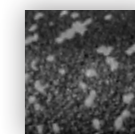
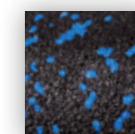
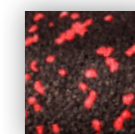
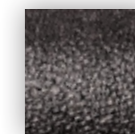



antibacterial protection



durable



recyclable

▶ MORE DETAILS 

### Spiky Ball

Sizes: Ø 7 cm / Ø 8 cm / Ø 9 cm / Ø 10 cm  
Material: PVC

The therapy ball can be used to train mobility, relieve tension and promote blood circulation. Thus, the hedgehog ball can be used in many ways and enables a wide range of different uses. The different colours indicate different sizes.

Available in four different sizes.

Article	6091	6092	6093	6094
Colour	Green	Yellow	Red	Blue





# CORK LINE



PLEASE CLICK DIRECTLY TO THE PRODUCT!

- Cork fascia roll Cortica ..... 66
- Cork fascia ball Bola ..... 68
- Cork fascia duo ball Dupla ..... 70
- Cork fascia set ..... 71
- Cork yoga mat Cortica ..... 72
- Cork yoga block ..... 74
- NEW** Cork Balance boards ..... 76



# TRENDY CORTICA

▶ MORE DETAILS 

 YouTube

## Trendy Roll Cortica

30 x Ø 10 cm  
Weight: 813 g  
Material: Cork

With its smooth design, the robust Trendy Cortica fascia massage roller made of cork ensures excellent trigger point therapy and full muscle massage.

Cork is a very robust and durable material with antibacterial and anti-allergic properties. In addition, our cork fascia roll is made from renewable raw materials, is recyclable and therefore particularly sustainable.

The product can be customized with doming or laser engraving upon request.

Incl. sales packaging



Article 9125KO



▶ MORE DETAILS 

## Trendy Roll Cortica Mini

15 x Ø 5,5 cm  
Weight: 96 g  
Material: Cork

The Trendy Cortica Mini fascia massage roller is particularly practical because of its handy size of 15 cm and can therefore be ideally integrated into everyday life.

The product can be customized with doming or laser engraving upon request.

Incl. sales packaging

Article 9108KO





▶ MORE DETAILS

**Fascia Ball Bola S Cork**

6 cm  
Weightt: 49 g  
Material: Cork

We also now offer the 6 cm Trendy Bola S cork.  
Its size makes it possible to massage even small, deeper and hard-to-reach tensions in the fascia and muscles.



The product can be customized with doming or laser engraving upon request.

Incl. sales packaging

Article 9116SKO

▶ MORE DETAILS

**Fascia Ball Bola M Cork**

8 cm  
Weight: 79 g  
Material: Cork

Trendy Bola M Cork was specially developed for the self-treatment of trigger points and tension.

The product can be customized with doming or laser engraving upon request.

Incl. sales packaging



- antibacterial protection
- customizable
- durable
- sustainable production
- recyclable

Article 9116MKO





▶ MORE DETAILS

YouTube

**Fascia Ball Dupla Cork**

16 x Ø 8 cm  
Weight: 154 g  
Material: Cork

Trendy Dupla cork is an excellent training tool for self-massage of trigger points. Due to its shape, it has a double punctual effect and is particularly suitable for the trigger point massage of parallel muscle strands. The intensity can be determined by the pressure you exert yourself. Cork is a very robust and durable material with antibacterial and anti-allergic properties. In addition, our cork fascia ball is made from renewable raw materials, is recyclable and therefore particularly sustainable.

The product can be customized with doming or laser engraving upon request.

Incl. sales packaging

- antibacterial protection
- customizable
- durable
- sustainable production
- recyclable



Article 9110KO

▶ MORE DETAILS

**Fascia Set Cork**

Material: Cork

Our Cortica mini fascia roller is now also available together with the new Bola S cork fascia ball.

The product can be customized with doming or laser engraving upon request.

Incl. sales packaging

- antibacterial protection
- customizable
- durable
- sustainable production
- recyclable



Article 9108SKO





**New**  
now as set available



▶ MORE DETAILS 

### Yogamat Cortica

180 x 60 x 0,4 cm  
Material: Cork, Natural Rubber

-   
customizable
-   
antibacterial protection
-   
optimal absorption
-   
durable
-   
sustainable production

The new yoga mat Cortica combines the great anti-slip properties of natural rubber mats with the pleasant natural material cork.

Cork is a very robust and durable material with antibacterial and anti-allergic properties. In addition, our cork yoga mat is made from renewable raw materials, is recyclable and therefore particularly sustainable.

Anti slip

Article 9550KO



You can use the mat on both sides, depending on whether you prefer more support for challenging exercises or want a warm, comfortable surface for meditation, for example.

The mat can be customized with UV printing upon request.





▶ MORE DETAILS 

**Yoga Block Cork**

23 x 15 x 7,5 cm  
 Weight: 665 g  
 Material: Cork

The cork yoga block is a versatile tool for many yoga exercises. It can serve as a sitting aid, as an arm extension for particularly demanding stretching exercises.

Cork is a very robust and durable material with antibacterial and antiallergic properties. In addition, our cork yoga block is made from renewable raw materials, is recyclable and therefore particularly sustainable.

			
antibacterial protection	durable	sustainable production	recyclable

Our yoga block is a real eye-catcher with its durable laser-engraved design - convince yourself of our high-quality yoga block!

The yoga block can be customized with laser engraving upon request.

Incl. sales packaging.



Backside view



Article	9011KO
---------	--------

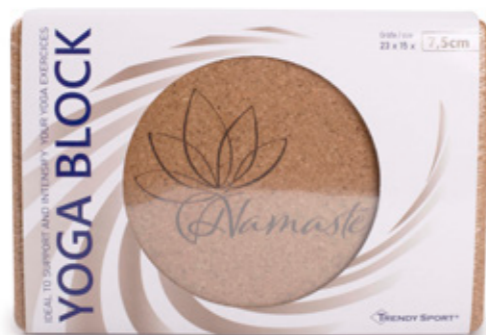



**NEW**  
soon  
available

▶ MORE DETAILS 

**Bamusta® Cortica Longo**

74 x 28 x 12 cm, 3,5 Kg  
Material: Cork, Multiply wood board

Our high-quality Bamusta® product range is now supplemented by the new cork surf board Bamusta® Cortica Longo, for which you receive a matching balance roll made of 100% natural cork as a set, which can also be used separately as a fascia roll.

Max. load limit 200 kg  
Incl. sales packaging

Article 9006KO



▶ MORE DETAILS 

**Bamusta® Cortica Aceno**

74 x 30 x 12 cm, 3 Kg  
Material: Cork, Multiply wood board



With the Bamusta® Cortica Aceno Set you can train your coordination, body tension, balance and mobility like on a surfboard. The product set is perfect for demanding balance exercises both at home and in the studio!

Max. load limit 200 kg  
Incl. sales packaging

Article 9004KO

challenging  
metatarsus

▶ MORE DETAILS 

 YouTube

**Bamusta® Cortica Circulo**

Ø 39,5 x 7,5 cm, 1,5 Kg  
Material: Cork, Multiply wood board, PP

Our high-quality Bamusta® product range is now complemented by the new cork balance board Bamusta® Cortica Circulo. The metatarsal creates a tilting movement so that you can train your coordination, body tension, balance and mobility with the Bamusta® Cortica Circulo. The product is perfect for balance exercises both at home and in the studio!

The robust board is a particularly safe training partner due to its non-slip cork coating and rounded



edges. The choice of materials not only impresses with its functionality, but is also particularly sustainable thanks to the use of long-lasting and renewable raw materials.

The board is hygienic due to the antibacterial effect of the cork and can be cleaned with a damp cloth if necessary. Convince yourself of Circulo and our other new products from the Bamusta® Cortica Line!

Max. load limit 200 kg  
Incl. sales packaging



closed cell structure



durable

Article 9005KO

# YOGA



PLEASE CLICK DIRECTLY TO THE PRODUCT!

- Yogamat Professional ..... 80
- NEW** Yoga mat Ecoline ..... 82
- Yoga belt ..... 84
- Yoga block ..... 88
- Yoga wheel Roda ..... 92
- Yoga swing Impulso ..... 94

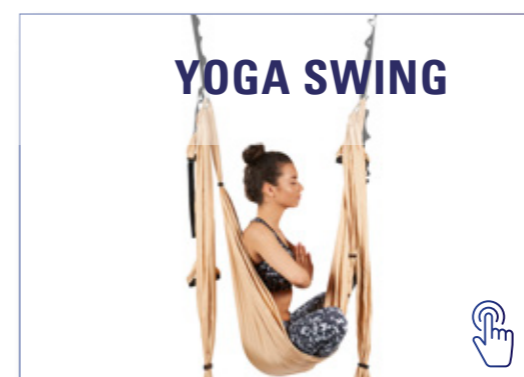
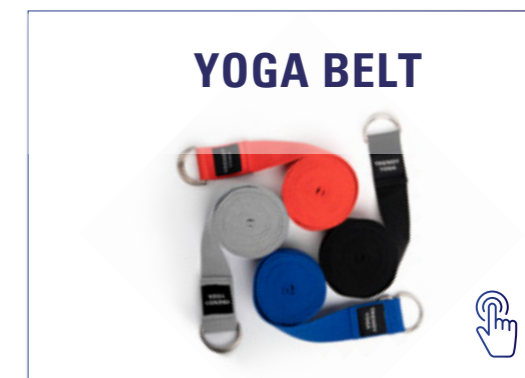
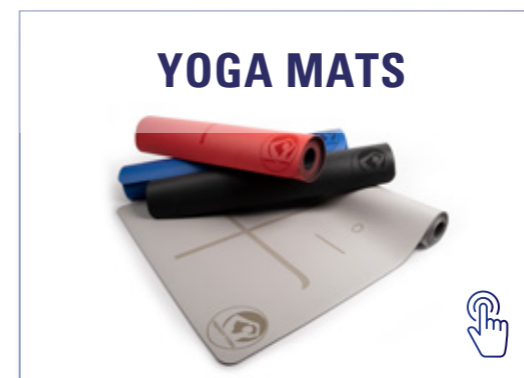





- antibacterial protection
- optimal absorption
- allergy friendly
- washable
- customizable
- durable
- recyclable
- 6P FREE

▶ MORE DETAILS

### YogaMat Professional

180 x 60 x 0,5 cm  
Material: 90% PVC, 10% Polyester, 6p free

The YogaMat Professional was specially developed for the professional yoga area and meets the high demands in all yoga areas. The absolutely non-slip mat consists of 90% PVC and 10% polyester, is 6p free and available with or without eyelets.

Colour	without eyelets	with eyelets
Grey	9020GR	9120GR
Anthracite	9020A	9120A
Blue	9020B	9120B
Purple	9020P	9120P
Red	9020R	9120R
Orange	9020OR	9120OR
Yellow	9020Y	9120Y
Green	9020G	9120G



also with eyelets available

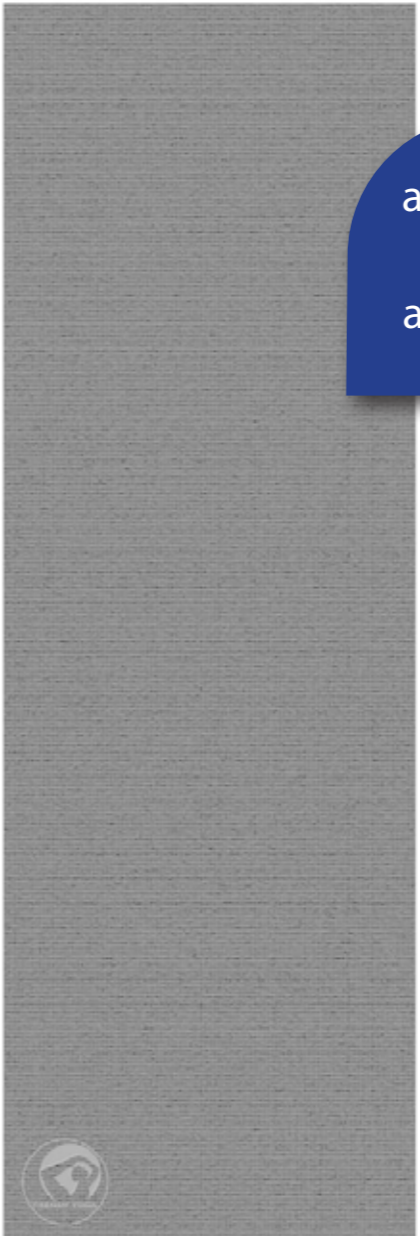

The yoga mat can be rolled up and down effortlessly and lies nicely flat on the floor. The mat is dirt and moisture repellent, easy to clean and even washable at 30 °. Choose between our 8 colours!

The mat can be customized with UV printing upon request.

**NEW!**  
now available

TRENDY YOGA  
eco line



-  antislip
-  antibacterial protection
-  optimal absorption
-  allergy friendly
-  customizable
-  recyclable

Incl. carrying strap



Colour	Mat	Strap	Mat with strap
Anthracite/Grey	9021A	9016GR	9021ASET
Green/Light green	9021G	9016G	9021GSET
Blue/Light blue	9021B	9016B	9021BSET
Beige/Taupe	9021BE	9016BE	9021BESET
Purple/Rosa	9021P	9016P	9021PSET

▶ MORE DETAILS 

**Trendy YogaMat Ecoline**

180 x 60 x 0,6 cm  
Material: TPE

We also now offer high-quality yoga mats made from pleasantly soft and environmentally friendly TPE, which are particularly suitable for allergy sufferers. With a visually appealing surface structure, the mat is not only non-slip on all

surfaces, but can also be used in two colors and on both sides. A high-quality cotton belt in the matching color is also available as an option. We offer the mats in many attractive color combinations. The mat can also be printed according to your wishes.

- 100% anti-slip on all surfaces
- 100% biodegradable
- 100% odorless
- Made without azo dyes
- Suitable for allergy sufferers  
(free from latex, rubber, PVC, heavy metals, cadmium and plasticizers)





▶ MORE DETAILS

**Yoga Belt Presilha**

Length: 180 cm, 10 Loops  
Material: Acrylic, Rubber, Cotton

The Presilha yoga belt is an ideal training aid, especially in the areas of pilates and yoga, as well as for physiotherapeutic exercises, as well as pre- or post-training stretching.

Incl. sales packaging.

Thanks to the loops, many different grip positions with feet and hands are possible. That is why the Yoga Presilha is irreplaceable as a stretching aid. As a training aid, Yoga Presilha can not only correct bad posture, but also improve flexibility and the range of motion.

- stretching and expansion aid
- foot can be placed in different positions
- correction of deficiencies and body shape
- flexibility and range of motion can be improved

Article 9014

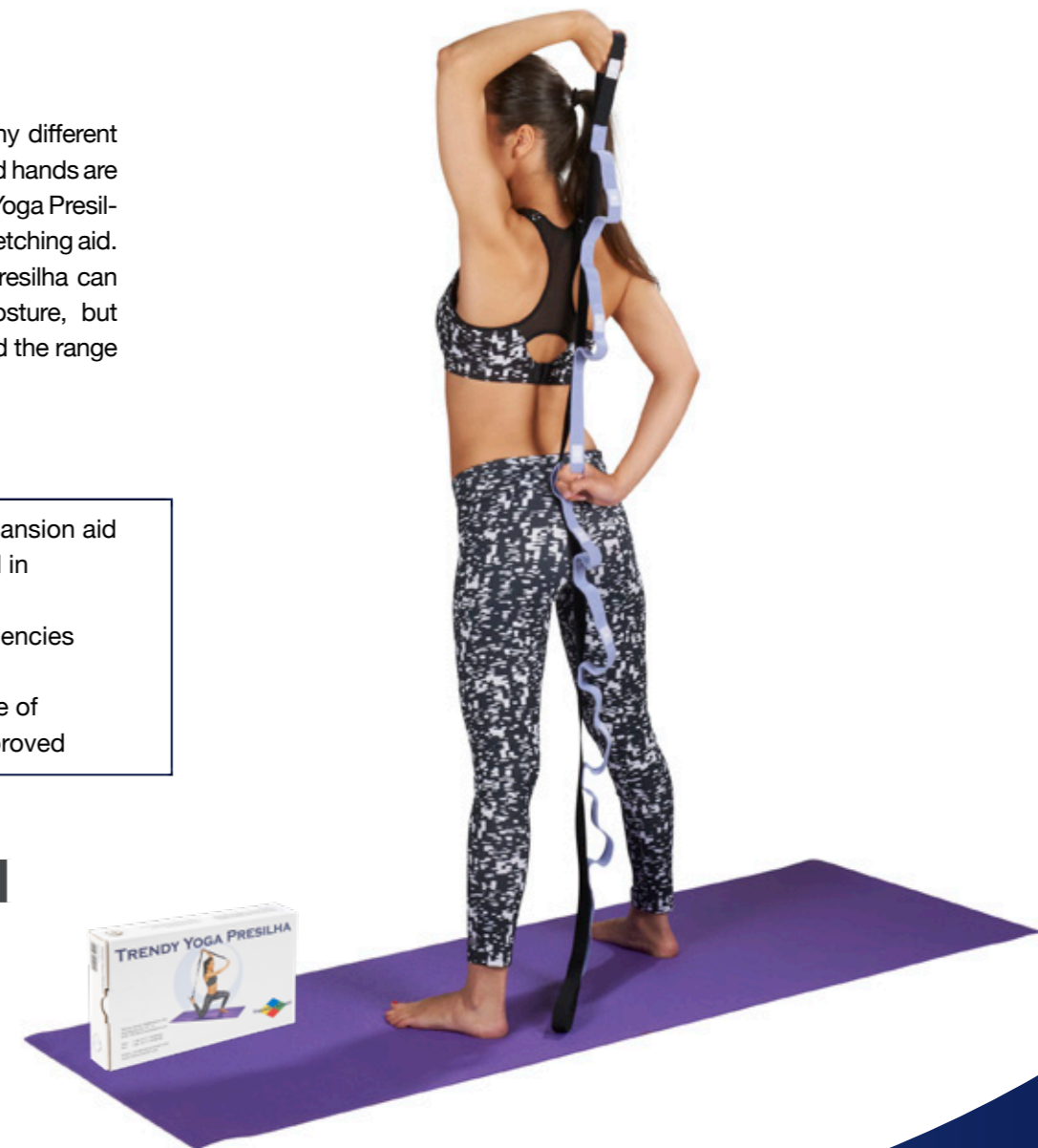
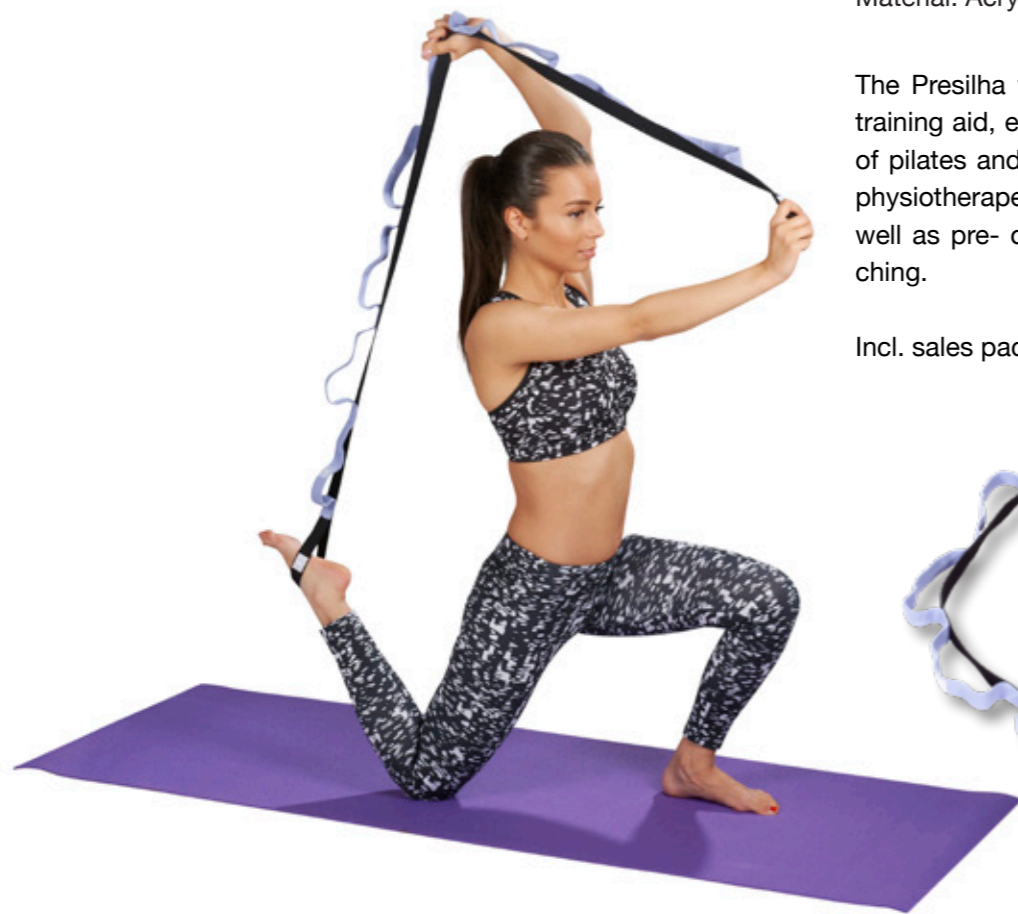



100% cotton

-  allergy friendly
-  washable
-  durable
-  recyclable

▶ MORE DETAILS 

### Trendy Yoga Belt

300 x 4 x 0,2 cm  
Material: Cotton

The yoga belt not only guarantees you a more precise execution of various exercises, but also significantly reduces the risk of overstretching. The belt also makes it easier for beginners to enter the world of yoga. The clasp made of two metal rings is particularly robust and popular. The yoga belt is available in four different colours!

Colour	Article
Anthracite	9013A
Blue	9013B
Red	9013R
Grey	9013GR



▶ MORE DETAILS 

### Yoga Belt Nature

300 x 4 x 0,2 cm  
Material: Cotton

The natural look of the Yoga Belt nature fits perfectly in the natural yoga product environment.

-  allergy friendly
-  washable
-  durable
-  recyclable



Article	9013N
---------	-------



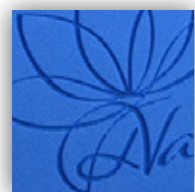
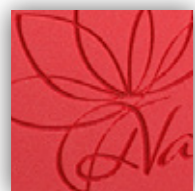
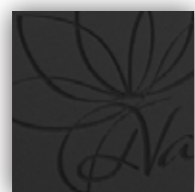

light weight



durable



recyclable

The 200g block is now even more stable and available in four different colours, 7,5 cm thick.

The yoga block can be customized with laser engraving upon request.

▶ MORE DETAILS 

**Yoga Block**

23 x 15 x 7,5 cm  
Weight: 200 g  
Material: EVA

The yoga block not only helps beginners with the implementation, but also guarantees advanced users correct execution of more complex exercises and is therefore an indispensable training aid for various yoga exercises.



Colour	Article
Anthracite	9011A
Red	9011R
Blue	9011B
Grey	9011GR





▶ MORE DETAILS 

**Yoga Block Bamboo**

23 x 15 x 7,5 cm  
 Weight: 621 g  
 Material: Bamboo

The yoga block Bamboo helps advanced learners to intensify their exercises in order to achieve greater success, while beginners achieve postures that would not even be possible without the block. Thanks to its cell-closed bamboo material, the block achieves a high level of hygiene and is characterized by its lightness and stability.

Incl. sales packaging.

Article 9011BA





▶ MORE DETAILS 

antislip surface

**Yoga Wheel Roda**

Ø 32 x 13 cm  
Material: TPE, ABS

Stretching - bending - massaging - balancing - stabilizing - our trendy Roda Yoga Wheel is a versatile training device and can be incorporated into various yoga exercises. It helps beginners to approach difficult exercises, advanced users can deepen positions. Trendy Roda supports you in building muscles, promotes mobility and helps to relieve tension.

Article 9060



antislip



durable

Stretching and warm-up exercises can be performed even more safely thanks to the anti-slip surface on the outside. The wood look gives the yoga wheel a very elegant and natural look. Convince yourself of the high quality of our yoga wheel!

Max. weight capacity 475 kg  
Incl. sales packaging.



▶ MORE DETAILS 

### Yoga Swing Impulso

Material: Nylon  
280 x 150 cm



washable



durable



recyclable

With the Yoga Swing Impulso tension can be released and strength can be built up at the same time. The rocking leads each position in the horizontal and vertical plane into the depths of yoga.

Since most of humanity suffers from back problems, inversion therapy is an indispensable part of the Trendy Impulso. Neck and pelvic problems can also be eliminated with the appropriate exercises.

This training device convinces with numerous positive effects. These include not only a deeper breathing technique, increased sense of balance, reduction of stress and better stretching, but also an ex-

pansion in strength, flexibility. The confidence in your own body can be extremely strengthened.

The Trendy Impulso contains some loops and handles to hold on or to relieve certain parts of the body. The stable fastening material can also be purchased.

Incl. sales packaging

#### Scope of delivery

- 2 x Loop strap
- 6x Stainless steel carabiner
- 2x Handles with foam



- greater freedom of movement
- the rocking deepens the yoga positions
- much deeper breathing techniques
- increased balance and better stretching
- relieves back-, neck- and pelvic-problems



#### Ceiling mount

(not included)

Article 9015



Article 8107



# PILATES



PLEASE CLICK DIRECTLY  
TO THE PRODUCT!

Pilates ring.....	98
Pilates ball .....	99
Pilates roll .....	100

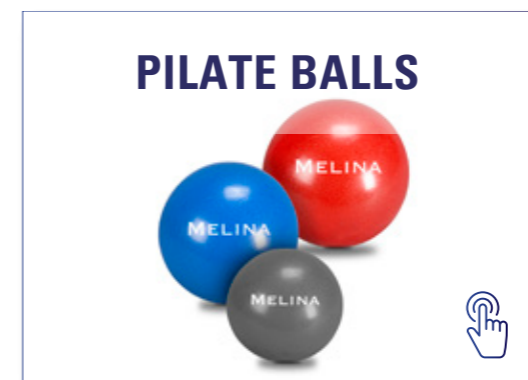



▶ MORE DETAILS 

**Pilates Ring Panelo**

Ø 38 cm  
Material: PP + TPR (handle),  
NBR (cover), Fiberglass (inside)

The Trendy Sport Pilates ring with a diameter of 38 cm lies comfortably in the hands thanks to the anti-slip handles and the rubber coating. The space-saving training device makes your Pilates training even more varied and strengthens your arm, shoulder, chest, thigh and buttock muscles.

Incl. sales packaging.



Colour	Article
Anthracite	9056A
Grey	9056



▶ MORE DETAILS 

**Trendy Pilates Ball Melina**

Sizes: Ø 19 cm, Ø 25 cm, Ø 30 cm  
Material: PVC

The original Trendy Pilates Ball Melina is produced of a soft foamed PVC material, can be inflated very easily with the inflating aid (blow pipe) and can be closed with the provided plug. It is a perfect training device to strengthen the back and abdominal muscles.



Article	9051A	9052B	9053R
Size	19 cm	25 cm	30 cm
Colour	Anthracite	Blue	Red

incl. inflation aid



Ø 19 cm



Ø 25 cm



Ø 30 cm

The Trendy Pilates Ball Melina is offering a wide range of exercises. A necessary inflation aid and plug are included in the scope of delivery.

Max. carrying capacity 60 Kg  
Incl. inflation aid

▶ MORE DETAILS 

**Pilates Roll Largo**

90 x Ø 15 cm  
Material: EVA

Thanks to the special surface structure, this EVA pilates roll offers more slip resistance and is versatile and can be cleaned hygienically.

Colour	Article
Anthracite	9001A
Blue	9001B



▶ MORE DETAILS 

**Pilates Roll Media**

91 x 15 x 7,5 cm  
Material: EVA

The half round pilates roll is an optimal pilates gym equipment for exercises, where upper body can recline on the dimensionally stable roll.

Colour	Article
Anthracite	9003A
Blue	9003B

-  closed cell structure
-  light weight
-  durable
-  recyclable

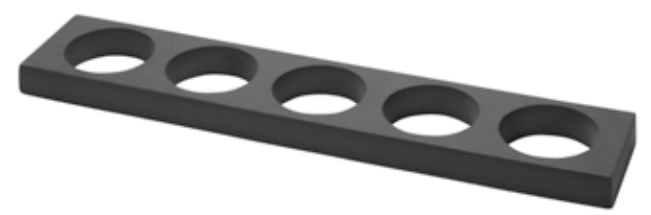

**Pilates Roll Pequeno**

30 x Ø 15 cm  
Material: EVA

The soft and robust Fascia Massage Roll cares with its smooth design for excellent trigger-point therapy and complete muscle massage.

Incl. sales packaging

Colour	Article
Anthracite	9101A
Blue	9101B



▶ MORE DETAILS 

 YouTube

▶ MORE DETAILS 

**Pilates Roll Mount**

96 x 19 x 5 cm  
Material: EVA

Our Trendy Roll Mount is used for space-saving storage of up to 5 Trendy Rolls, suitable for all rolls with 15 cm diameter.

Article	9041A
---------	-------

# LOOPS & TUBES



PLEASE CLICK DIRECTLY TO THE PRODUCT!

- Hip Loops ..... 104
- Tone Loops ..... 106
- Trendy Rubber Band ..... 108
- Limite Band ..... 110
- Premium Power Sleeve ..... 112
- Premium Gym Tube ..... 115





antislip  
silicone  
coating

**Light**

Size: 60 x 6 cm  
*for Rehabilitation*

**Medium**

Size: 66 x 7 cm  
*for Aerobics & Rehabilitation*

**Heavy**

Size: 72 x 8 cm  
*for Aerobics & Advanced*

▶ MORE DETAILS 

**Hip Loop**

Material: 60% Nylon, 40% Latex  
Inside: Silicone coating

The new Hip Loops can be used for versatile training of individual muscle groups - ideal for strengthening and stretching. The loops made of 60% nylon and 40% latex are very skin-friendly and can also be washed. The inside silicone-coating has excellent anti-grip properties, which ensures a secure hold during training.

The Hip loop is available in three different strengths, which you can easily recognize by the different colours.

Incl. sales packaging.



Article	69911	69912	69913
Strength	Light	Medium	Heavy
Colour	Yellow	Red	Grey



washable



customizable



durable





▶ MORE DETAILS 

**Trendy Tone Loops**

30 x 5 cm  
Material: Rubber

The Tone Loops are equally suitable for building muscle in rehabilitation and aerobics and for versatile training of individual muscle groups. The Tone Loops have no seam and are therefore extremely hard-wearing and safe. The different colours of the Tone Loops indicate different levels of difficulty.

without seams



-  antibacterial protection
-  customizable
-  durable
-  recyclable

Article	67080	67081	67082	67083	67084	67085
<b>Strength</b>	X-Light	Light	Medium	Heavy	X-Heavy	XX-Heavy
<b>Colour</b>	Orange	Yellow	Green	Red	Blue	Grey

Traction 6,8-9 KG  
Thickness: 0,35 mm  
*for Rehabilitation*



Traction 9-11 KG  
Thickness: 0,5 mm  
*for Rehabilitation*



Traction 11-13,5 KG  
Thickness: 0,7 mm  
*for Aerobics and Rehabilitation*



Traction 13,5-15,8 KG  
Thickness: 0,9 mm  
*for Aerobics and Rehabilitation*



Traction 15,8-18 KG  
Thickness: 1,1 mm  
*for a musculature already trained*



Traction 18-20 KG  
Thickness: 1,3 mm  
*for a musculature already trained*





-  antibacterial protection
-  durable
-  recyclable

Article	67091	67092	67093	67094	67095	67096
<b>Strength</b>	X-Light	Light	Medium	Heavy	X-Heavy	XX-Heavy
<b>Colour</b>	Orange	Yellow	Green	Red	Blue	Grey

▶ MORE DETAILS 

**Rubber Band**

Length: 105 cm  
Material: Rubber

The Trendy Rubber Band produces a great effect despite its simple application, because you can train almost all muscle parts. The tape is also very useful for rehabilitation or aerobics. The rubber tapes have no seam and are therefore extremely hard-wearing and safe. The different colours indicate different levels of difficulty.

Incl. sales packaging

without seams



Traction 7-15 KG  
Thickness: 13 mm  
*for Rehabilitation*

Traction 14-27 KG  
Thickness: 17 mm  
*for Rehabilitation*

Traction 11-29 KG  
Thickness: 21 mm  
*for Aerobics and Rehabilitation*

Traction 18-32 KG  
Thickness: 26 mm  
*for Aerobics and Advanced*

Traction 15-38 KG  
Thickness: 32 mm  
*for a musculature already trained*

Traction 22-56 KG  
Thickness: 45 mm  
*for a musculature already trained*

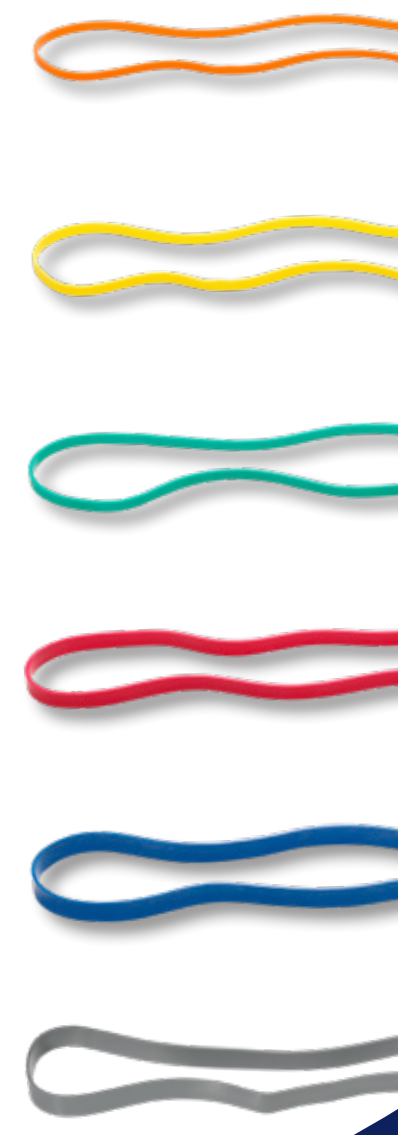



Traction up to 4,5 KG  
Thickness: 0,35 mm  
for Rehabilitation

Traction up to 5,5 KG  
Thickness: 0,40 mm  
for Rehabilitation

Traction up to 6,8 KG  
Thickness: 0,45 mm  
for Aerobics/Rehabilitation

Traction up to 7,8 KG  
Thickness: 0,50 mm  
for Aerobics/Advanced

Traction up to 9,1 KG  
Thickness: 0,55 mm  
for a musculature already trained

Traction up to 10 KG  
Thickness: 0,60 mm  
for a musculature already trained

▶ MORE DETAILS

**Trendy Limite Roll**

250 cm x 15 cm  
Material: Natural Latex

Trendy Limite is a 25 meter long fitness band that you can individually cut to the required length and can therefore be adapted extremely flexibly to different requirements and exercises.

- length of 25 meters for self-cutting
- Trendy Limite box with slot
- high quality material
- extremely elastic



▶ MORE DETAILS

**Trendy Limite Band**

2500 cm x 15 cm  
Material: Natural Latex

The extremely elastic band made of skin-friendly natural rubber is suitable for gentle muscle building and stretching in the rehabilitation and fitness area. It also promotes flexibility and coordination. The limit band has a progressive pull resistance and is available in six different resistances and colours, which means that you have the perfect choice for your level of training and opportunities for improvement.

Incl. sales packaging



Article	67170-25	67171-25	67172-25	67173-25	67174-25	67175-25
<b>Strength</b>	X-Light	Light	Medium	Heavy	X-Heavy	XX-Heavy
<b>Colour</b>	Orange	Yellow	Green	Red	Blue	Grey

Article	67170	67171	67172	67173	67174	67175
<b>Strength</b>	X-Light	Light	Medium	Heavy	X-Heavy	XX-Heavy
<b>Colour</b>	Orange	Yellow	Green	Red	Blue	Grey





antibacterial protection



durable

▶ MORE DETAILS

**Premium Power Sleeve**

Length: 160 cm  
 Material: Latex, PP (sleeve, webbing)  
 NBR (handle)

The Power Sleeve Tubes are characterized by their high applicability mainly in the areas of fitness, rehabilitation and aerobics. They are mainly used for stretching of the upper body and the legs. You will achieve particular success in building muscles and in improving

your overall fitness and posture. The high quality material such as the nylon cover and the tight connection between handle and tube is preventing the tube from wear out and that's the correct foundation to reach your goals even faster.

Article	69811	69812	69813	69814
Strength	Light	Medium	Heavy	X-Heavy
Colour	Yellow	Green	Red	Blue



▶ MORE DETAILS

**Flex Tube Mount**

60 x 13 x 10 cm (L x W x H)  
Material: Steel, coated

With the help of the Trendy Tube Rack, you can easily store up to 140 Trendy Tubes in an organized and space-saving manner.

Article 67020



▶ MORE DETAILS

**Premium Gym Tube**

Length: 140 cm  
Material: Latex, NBR (handle), PP (webbing)

The original Tubes by Trendy Sport are suitable to build up muscles in rehabilitation as well as for Aerobics. They are used for stretching exercises for upper body and legs. Stimulates the muscle building, improves the fitness and body alignment.



Article	68811	68812	68813	68814
<b>Strength</b>	Light	Medium	Heavy	X-Heavy
<b>Colour</b>	Yellow	Green	Red	Blue

# ATS LINE



PLEASE CLICK DIRECTLY TO THE PRODUCT!

- ATS® Curl Barbell ..... 118
- ATS® Training Barbell ..... 120
- ATS® Premium Barbell ..... 122
- ATS® Triceps Trainer ..... 124
- ATS® Squat Hex Bar ..... 125
- ATS® Barbell storage ..... 126
- ATS® Accesories ..... 128
- ATS® PU Disks ..... 130
- ATS® Premium Bumper Plates ..... 132
- ATS® Weight disks accesories ..... 134
- ATS® Drop pads ..... 136
- ATS® Power sled ..... 138
- ATS® Plyo box..... 140
- ATS® Pull up rack ..... 142

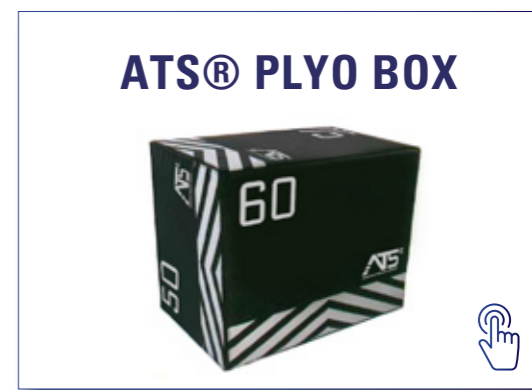



▶ MORE DETAILS 

**ATS® Curl Barbell**

120 x Ø 5 cm  
Material: Steel

We offer a large selection of training bars to match our ATS® Polyurethan Disks and our Premium Bumper Plates. We offer this high-quality curl barbell with a handy total length of 120 cm and a sleeve diameter of 5 cm. The curl bar is particularly suitable for efficient training of the biceps, triceps and shoulder muscles and, thanks to the corrugated grip surface, offers maximum safety and

comfort during your training. The training bar is made of robust hard chrome-plated solid steel and is characterized by high tensile and compressive strength with simultaneous elasticity. Together with the noble end caps and rubber rings in ATS® design, you will be amazed by the design, function and quality!

Article 3021

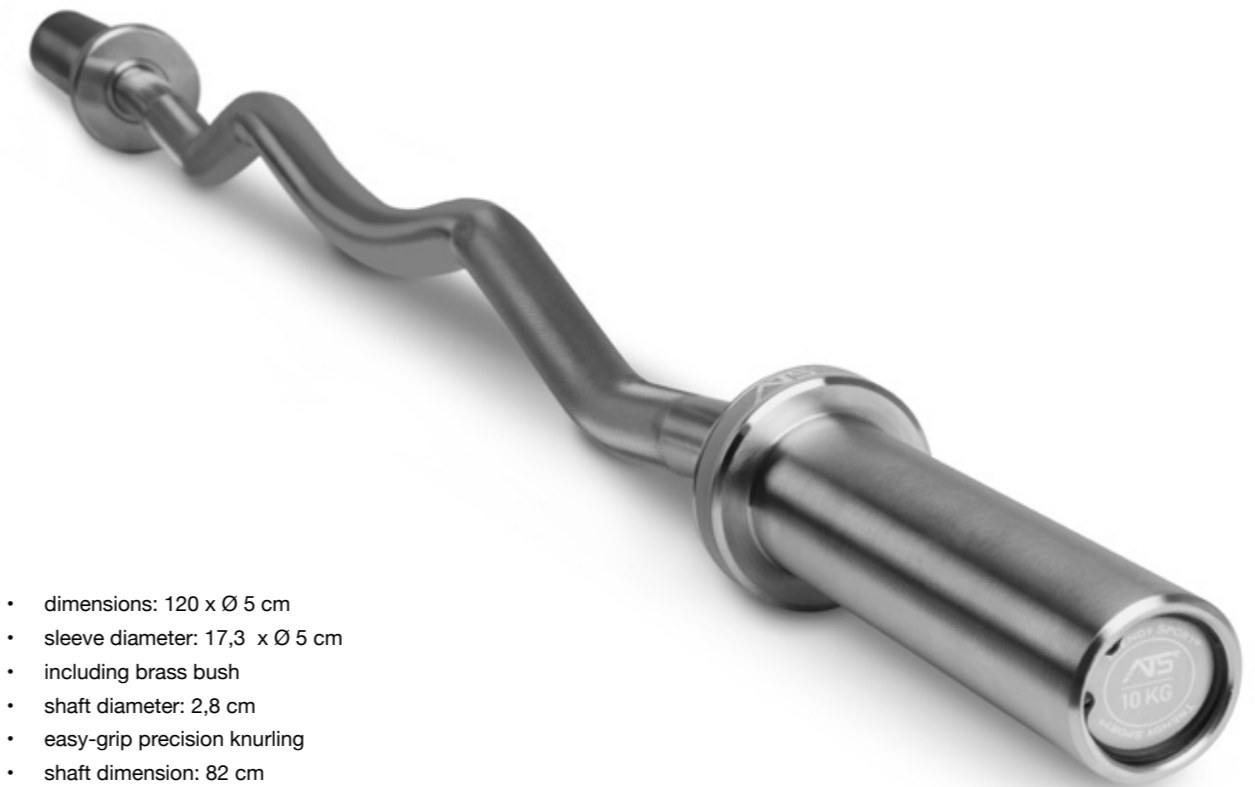

- dimensions: 120 x Ø 5 cm
- sleeve diameter: 17,3 x Ø 5 cm
- including brass bush
- shaft diameter: 2,8 cm
- easy-grip precision knurling
- shaft dimension: 82 cm
- material and finish: solid steel, hard chrome-plated
- weight: 10 Kg
- maximum weight capacity: 225 Kg / 500 lbs

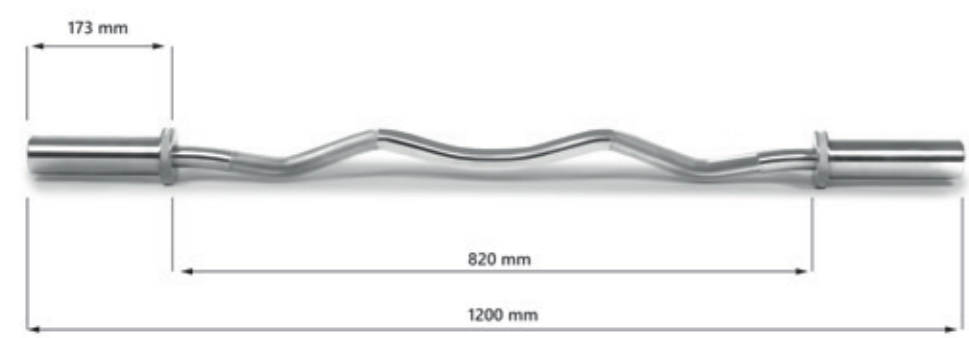



max load  
225 Kg /  
500 lbs

- dimensions: 220 x Ø 5 cm
- shaft diameter: 41 x Ø 5 cm
- including brass bush
- without middle mark
- shaft diameter: Ø 2,8 cm
- shaft dimensions: 131 cm
- complies IPF/IWF standard
- easy-grip precision knurling
- finish: steel with hard chrome coating / black oxide coating
- weight: 20 Kg
- load capacity: 225 Kg / 500 lbs

▶ MORE DETAILS

**ATS® Training Barbell 220 cm**

220 x Ø 5 cm  
Material: Steel

Our 220 cm long Olympic competition bar corresponds to international basic dimensions and fits all weight plates with a shaft diameter of 5 cm for our Premium ATS® polyurethane plates.

With a maximum load capacity of 225 kg and a weight of 20 kg, it is suitable for both amateur and professional use, whether for powerlifting, weightlifting or bodybuilding. The integrated brass bushing ensures smooth concentricity and, together with the corrugated knurling of 44 cm, offers comfortable handling.

Chromed	3023
Black Oxid	3024

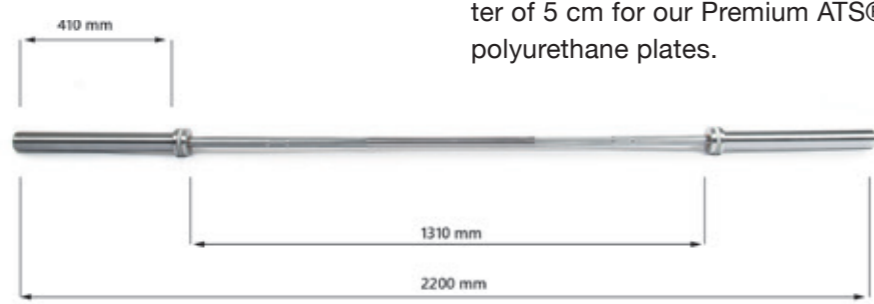

▶ MORE DETAILS

**ATS® Training Barbell 180 cm**

180 x Ø 5 cm  
Material: Steel

With a total length of 180 cm, this high-quality multifunctional barbell offers a space-saving solution compared to our 220 cm Olympic barbells. The product convinces with a 39 cm knurled grip surface and the high-quality brass bushing, which ensures optimal concentricity in comfort and quality. The 180 cm bar with its own weight of 13,5 kg can also be loaded with 225 kg and is ideally suited for amateur as well as professional weight lifting.

Our Barbells are made of high-quality solid steel with a timeless hard chrome coating and a cool black anodized coating and are therefore optimally protected against wear and corrosion as well as extremely tensile and pressure-resistant and yet very elastic. Together with the noble end caps and rubber rings in ATS® design, you set new design and quality standards in your home studio or professional fitness studio!

Icons representing product features: antislip, antibacterial protection, and durable.

- dimensions: 180 x Ø 5 cm
- sleeve diameter: 25,5 x Ø 5 cm
- including brass bush
- without middle mark
- shaft diameter: Ø 2,8 cm
- shaft dimensions: 123 cm
- complies IPF/IWF standard
- easy-grip precision knurling
- material: hard chromed steel
- weight: 13.5 Kg
- load capacity: 225 Kg / 500 lbs



Article	3022
---------	------



max load  
680 KG /  
1500 lbs

- dimensions: 5 cm x 220 cm
- shaft diameter Ø 5 cm x 41 cm
- including brass bush without middle mark
- shaft diameter: Ø 2,8 cm
- shaft dimensions: 131 cm
- complies IPF/IWF standard
- easy-grip precision knurling
- material: steel with hard chrome coating / black oxide coating
- weight: 20 KG
- load capacity: 680 KG / 1500 lbs

Chromed	3025
Black Oxid	3026

▶ MORE DETAILS

### ATS® Premium Barbell 220 cm

220 x Ø 5 cm  
Material: Steel

Our 220 cm long Olympic competition barbell corresponds to international basic dimensions and fits all weight plates with a weight plate holder of 5 cm diameter, e.g. for our Premium ATS® polyurethane plates.

With a maximum weight capacity of 680 kg and a weight of 20 kg, it is particularly suitable for professional weight training - whether powerlifting, weightlifting or bodybuilding. The integrated brass bushing ensures smooth concentricity and, together with the corrugated knurling of 44 cm, offers comfortable handling.

Our premium Olympic bars are made of high-quality solid steel with a timeless hard chrome coating and a cool black anodized

coating and are therefore optimally protected against wear and corrosion as well as extremely tensile and pressure-resistant and yet very elastic. Together with the elegant end caps and rubber rings in ATS design, you set new design and quality standards in your fitness studio!

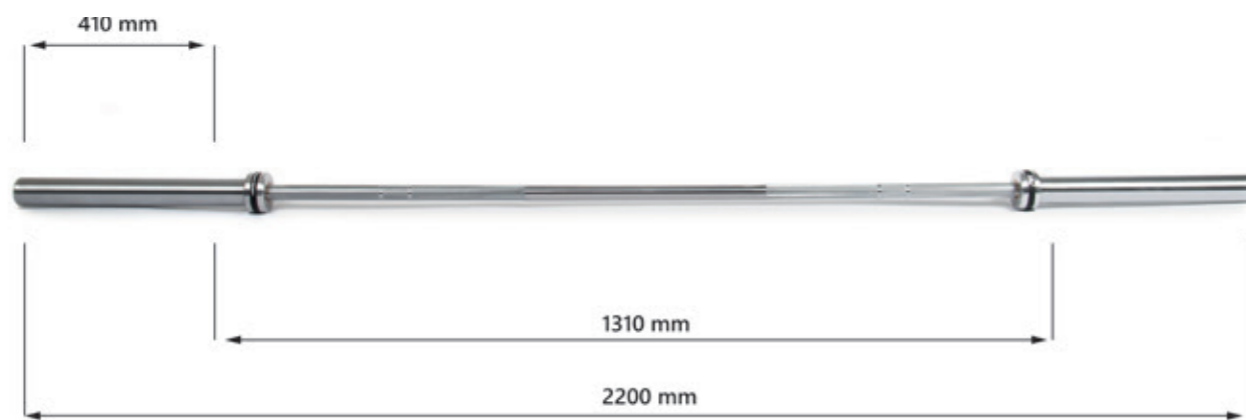



▶ MORE DETAILS 

### ATS® Triceps Trainer

86,5 x 19 cm  
Material: Steel

Our new triceps trainer enables a particularly ergonomic and gentle training through the natural hand position

The Triceps Trainer fits all weight plates with a weight plate holder of 5 cm diameter, e.g. for our Premium ATS® polyurethane plates.

Article 3052



- dimensions: 86,5 x 19 cm
- shaft diameter 16 x Ø 5 cm
- including brass bush
- easy-grip precision knurling
- material: steel electroplated
- weight: 12 Kg
- load capacity: 100 Kg

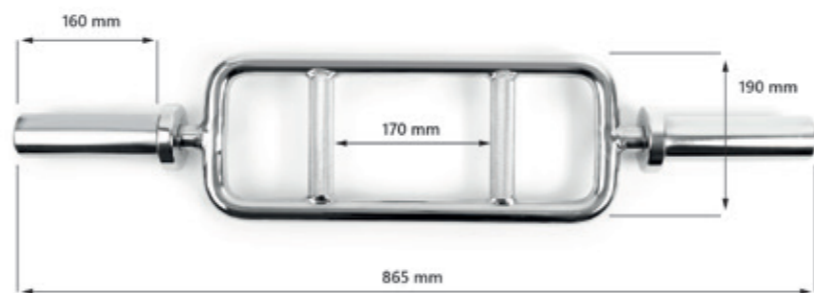

▶ MORE DETAILS 

### ATS® Squat Hex Bar

142 x 40 cm  
Material: Steel

The new Squat Hex Bar enables more stable training than with barbells. You stand in the middle of the Hex bar and grasp the ribbed handles on the side, which give you a lot of grip. This makes the posture much more precise during training and you can put significantly more weight on.

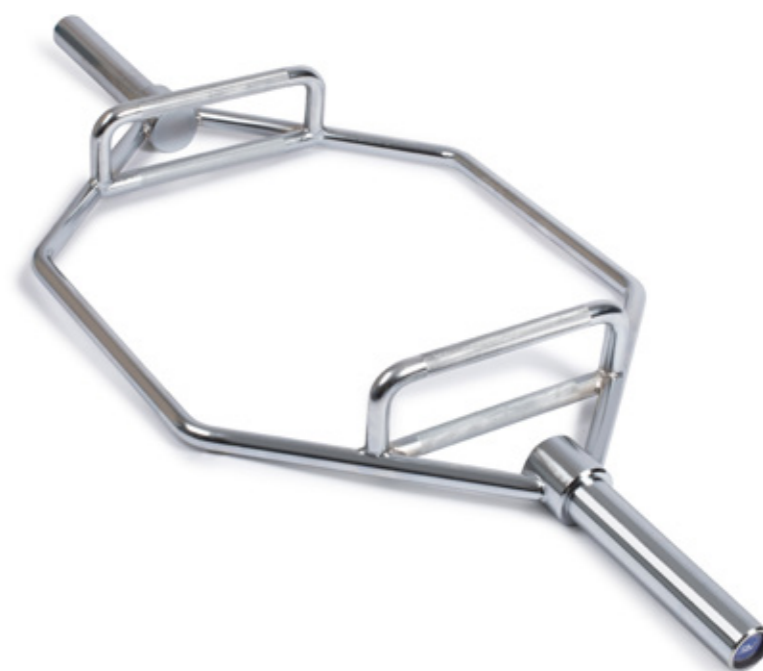

- dimensions: 142 x 40 cm
- shaft diameter 32 x Ø 5 cm
- including brass bush
- easy-grip precision knurling
- material: steel electroplated
- weight: 20 Kg
- load capacity: 150 Kg

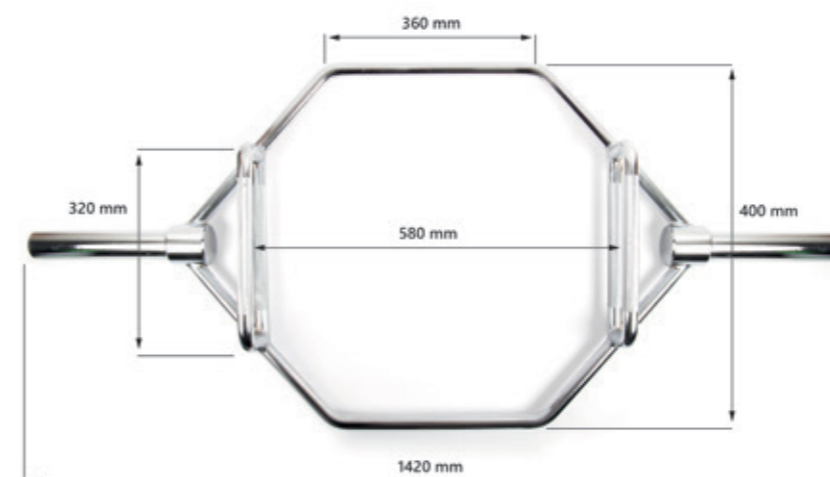

Article 3051



▶ MORE DETAILS 

**ATS® Floor Bar Holder**

Art. No. 3043: 29 x 29 x 15,5 cm (L x W x H)  
 Art. No. 3044: 84 x 63 x 23 cm (L x W x H)  
 Material: Steel



This massive rack made of steel with an elegant black lacquer finish offers space for up to ten training bars. The storage stand can be screwed to the floor and, together with extreme

shock resistance, offers a high level of safety and comfort. The rack is available in two versions. The larger version can hold 10 bars, the smaller 4 bars.

Article	3043	3044
Bar amount	4	10



▶ MORE DETAILS 

**ATS® Wall Mount Bar Holder**

88 x 12 x 135 cm (L x W x H)  
 Material: Steel

This wall mounting system can be screwed to the wall at any distance and can fit up to eight barbells.

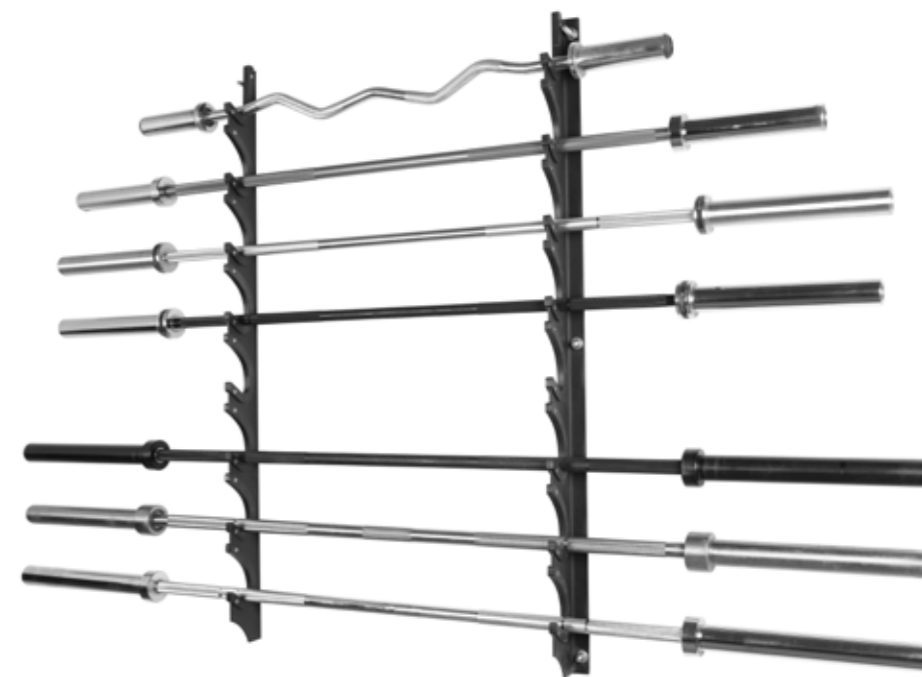

Article	3042
---------	------







▶ MORE DETAILS 

**ATS® Neck Pad**

45 x Ø 8 cm  
Material: Foam, Oxford fabric cover

Our new neck pad suitable for our ATS® barbells makes your training even more comfortable. The neck pad can be securely closed with a velcro fastener. The polyester surface is extremely hygienic and easy to clean.

Article	3053
---------	------

▶ MORE DETAILS 

**Spring Lock 5 cm**

Material: Steel

The Spring Locks secure your weight plates optimally on your barbell and are suitable for all bars with a diameter of 5 cm.

Price per pair.

Article	2058-50
---------	---------



▶ MORE DETAILS 

**ATS® Secure Shutter 5 cm**

Material: Aluminium

The ATS® Secure Shutters made of high-quality cast aluminum ensure extra convenience when securing and changing your weight plates. The shutter are available in plain black or silver and suitable for all bars with a diameter of 5 cm.

Price per piece.

Silver	2059GR-50
Black Oxid	2059A-50





▶ MORE DETAILS 

**ATS® Premium Polyurethan Disk**

Inside diameter: Ø 5 cm  
Material: Cast iron, PU

Our new Aperto Trendy Sport® polyurethane disks impress with their unique design - with the black matt surface, which is interrupted by grey sporty lines, they not only set new optical standards in weight training and fit on any barbell with a 5 cm diameter.



Thanks to the PU coating, the disks are extremely abrasion and scratch resistant and therefore very durable. The four integrated anti-slip handles ensure ergonomic handling. The ATS® disks are available in seven different weight levels from 1,25 Kg to 25 Kg.

Article	3010-0125	3010-0250	3010-0500	3010-1000	3010-1500	3010-2000	3010-2500
<b>KG</b>	1,25 kg	2,5 kg	5 kg	10 kg	15 kg	20 kg	25 kg
<b>Outside Ø</b>	19,5 cm	23 cm	28 cm	36 cm	37 cm	45 cm	45 cm
<b>Thickness</b>	2 cm	2,5 cm	3 cm	3 cm	4 cm	4 cm	5 cm



antislip



antibacterial protection



durable

100% recycled rubber







▶ MORE DETAILS 

**ATS® Premium Bumper Plates**

Inside diameter: Ø 5 cm  
 Outside diameter: Ø 45 cm  
 Material: 100% Rubber

Our new Aperto Trendy Sport® Premium Bumper Plates in exclusive Trendy Sport Design offer you an even larger selection of high-quality equipment for your strength training! The weight plates consist of 100% recycled rubber granulate and are therefore not only sustainable, but also extremely durable and robust. The material makes the impact extremely quiet and gentle on the floor. Nevertheless, ATS® Rubber Disks are flexible and at the same time extremely abrasion and scratch resistant.



-   
antislip
-   
extremely good absorption
-   
very good acoustic insulation
-   
durable
-   
sustainable production

All sizes have the same diameter of 45 cm, which means that the weight is evenly distributed on the floor when you put it down, making it ideal for dynamic training. The discs fit on any dumbbell bar with a 50 mm diameter, such as our ATS® bars, but can also be incorporated into your training without a bar. The ATS® weight plates are available in five different weight levels from 5 Kg to 25 Kg.



Article	3011-0500	3011-1000	3011-1500	3011-2000	3011-2500
KG	5 kg	10 kg	15 kg	20 kg	25 kg
Thickness	35 mm	65 mm	90 mm	120 mm	140 mm



▶ MORE DETAILS 

### ATS® Disk Rack

61 x 71,5 x 137 cm (L x W x H)  
Material: Steel

With this high-quality, solid weight plate stand, you can store all plates with a hole diameter of 5 cm in a clear manner.

Length of the handrails: 31,5 cm.

#### Suitable for:

- 90 x 1,25 Kg PU ATS Plates
- 72 x 2,5 Kg PU ATS Plates
- 60 x 5 Kg PU ATS Plates
- 60 x 10 Kg PU ATS Plates
- 42 x 15 Kg PU ATS Plates
- 42 x 20 Kg PU ATS Plates
- 36 x 25 Kg PU ATS Plates

Article 3041



▶ MORE DETAILS 

### ATS® Disk mobile Rack

130 x 28 x 32 cm (L x W x H), 16 Kg  
Material: Steel

This practical weight plate stand is suitable for all types of weight plates. 16 compartments offer space for narrow and wide plates and thus ensure order and overview. With the help of the transport handle and the rollers on the opposite side, the discs and stand can be moved comfortably.

Article 3045

**New**  
now  
available



#### Suitable for:

- 54 x 5 Kg Bumper plates
- 24 x 10 Kg Bumper plates
- 18 x 15 Kg Bumper plates
- 12 x 20 Kg Bumper plates
- 12 x 25 Kg Bumper plates



**New**  
now  
available



▶ MORE DETAILS 

**ATS® Drop pads pair**

77 x 62 x 15 cm (L x W x H)  
Material: Anti-Slip-PVC  
Füllung: recycled cotton

-   
antislip
-   
antibacterial protection
-   
durable

Our new ATS® steam blocks protect your floor and weights with their robust foam padding. So you can let your weights fall quietly, even on sensitive floors. Ventilation openings on the sides of the scratch-resistant cover ensure the longevity of your upholstery, and they can be transported easily using the handles.

recycled cotton

For more than 5000 serves price in pairs.

Article 3055





**New**  
now  
available

-   
antislip
-   
antibacterial  
protection
-   
durable

▶ MORE DETAILS 

**ATS® Power Sled**

106 x 50 x 115 cm (L x W x H), 45 Kg  
Material: Steel

Our new ATS® weight sled is the perfect training device for our ATS Line and, thanks to the rails, allows for floor-friendly pulling and pushing exercises. Our ATS® Premium PU Disks or Premium Bumper Plates are available to match the weight sled.

Article 3057





▶ MORE DETAILS 

**ATS® Plyo Box**

75 x 60 x 50 cm ( L x W x H), 20 Kg  
Material: PVC-cover, EVA-padding, wood construction

With our new ATS® Plyo Box you can train your jumping power, speed, coordination and agility. The soft EVA cover and the non-slip PVC surface ensure safe training and is easy to clean.

The box consists of a stable wooden construction, offers three different training heights and is therefore suitable for both beginners and advanced users.

Article 3056



▶ MORE DETAILS 

**ATS® Soft Plyo Box Set**

Material: PVC cover, EPE core

Size (L x W x H)

- Box 01: 90 x 73 x 15 cm
- Box 02: 90 x 73 x 30 cm
- Box 03: 90 x 73 x 45 cm
- Box 04: 90 x 73 x 60 cm

With our new ATS® Soft Plyo boxes we offer four different heights with a jumping surface of 90 x 73 cm. Thanks to a high-density EPE core, the boxes are very durable and also reduce the risk of injury.

The boxes can be combined as desired and securely connected with the Velcro fasteners. This allows you to individually adapt and increase your performance level.

The set contains 4 boxes.



Article 3058



**New**  
now available



**New**  
now available

▶ MORE DETAILS 

**ATS® Pull up bar**

117 x 55 x 48 cm (L x W x H)  
Material: Steel

Our new ATS® pull up bar offers you the highest quality, high resilience, many different grip options and is a real eye-catcher thanks to its two-tone design!

Article 3061

-   
antslip
-   
antibacterial protection
-   
durable

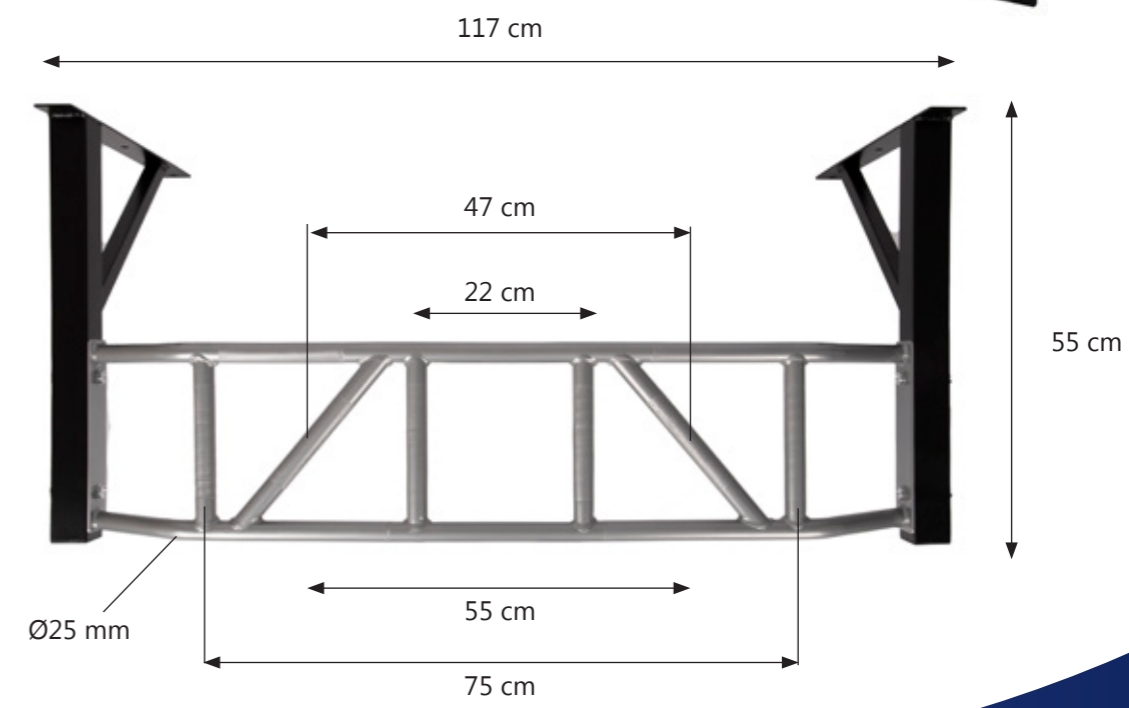



# WEIGHTS



PLEASE CLICK DIRECTLY TO THE PRODUCT!

- Body Bar Pesos ..... 146
- Pump Set TS ..... 148
- Pesos Aperto Pump Set ..... 150
- NEW** Hex Dumbbells ..... 152
- Chrome Dumbbells ..... 157
- Vinyl Dumbbells ..... 158
- Kettlebells Black ..... 160
- Kettlebells Vinyl ..... 161
- Weight ball Esfera..... 162
- Slam ball Esfera ..... 163
- NEW** Weight bags Esfera ..... 164
- Weight cuffs ..... 166





▶ MORE DETAILS

**Trendy Pesos Body Bar**

Lenght 125 cm / Ø 3 cm  
Material: Cast iron, PU (head),  
tear-proof foam, rubber



The Pesos Body Bar is perfect for optimizing your workout and getting into your workout easily.  
With the help of the different weight levels, which are colour-coded, you

can adjust the weight exactly to your fitness level. A rubberized grip surface gives you a particularly good grip.

Article	5001	5002	5003	5004	5005
KG	1 kg	2 kg	3 kg	4 kg	5 kg
Colour	Grey	Light blue	Red	Green	Yellow

Article	5006	5007	5008	5009	5010
KG	6 kg	7 kg	8 kg	9 kg	10 kg
Colour	Purple	Orange	Brown	Blue	Anthracite

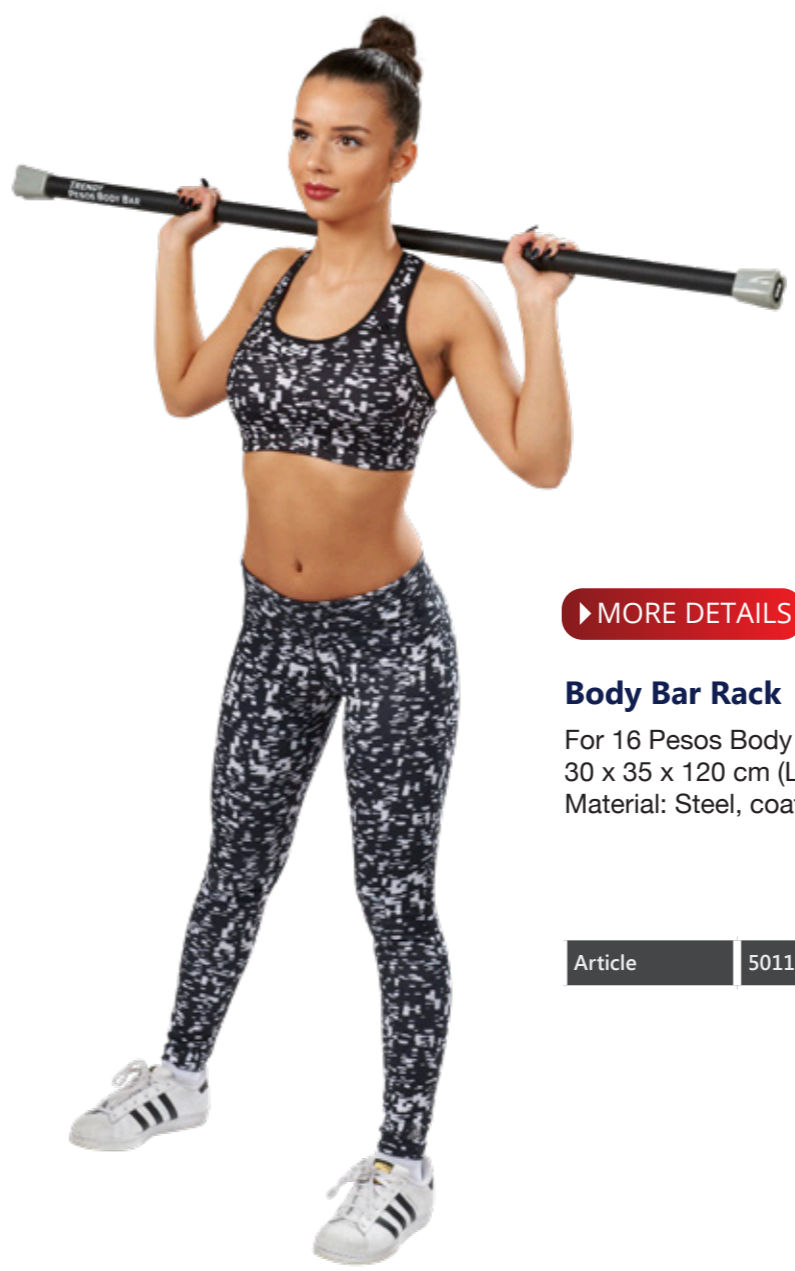

▶ MORE DETAILS

**Body Bar Rack**

For 16 Pesos Body Bar  
30 x 35 x 120 cm (L x W x H)  
Material: Steel, coated

Article	5011
---------	------





**Trendy Premium Bar RS - 1 KG**

Ø 3 cm / length 140 cm  
 adapter length 21 cm  
 max. weight capacity 20 Kg



▶ MORE DETAILS

**Premium Pump Set Rack**

For 20 Premium Pump Set RS  
 Material: Steel, coated

Article 2061



**Secure Shutter**

for Ø 3 cm barbell  
 price per pair



Article 2059

set incl. shutter

▶ MORE DETAILS

**Pump Set TS**

The new Pump Set TS, consisting of a 140 cm long barbell with two practical quick-release fasteners and 3 pairs of weight plates, each weighing 1,25 Kg, 2,5 Kg and 5 Kg, is versatile and can be used not only in the gym, but also at home.

The rubberized discs can be used alone or in combination with the bar for an effective full-body workout. Convince yourself of our new pump set!



Article 2050TS

- Set consisting of:**
- 1x Bar (1kg), Ø 3 cm
  - 2x Secure shutter
  - 2x 1,25 kg Weight Disc
  - 2x 2,50 kg Weight Disc



**1,25 k**

Inner Ø 3,2 cm  
 Outside Ø 18,5 cm  
 Thickness 2 cm

**2,5 kg**

Inner Ø 3,2 cm  
 Outside Ø 21,5 cm  
 Thickness 2,5 cm

**5 kg**

Inner Ø 3,2 cm  
 Outside Ø 24,5 cm  
 Thickness 3 cm



### Trendy Pesos Aperto

Inner Ø 3 cm  
Material: Cast iron, vinyl

The Pesos Aperto disks with cast core and vinyl coating are versatile. You can individually integrate them into your training session on your Pesos Barbell and also through the handle construction.

Pesos Aperto is available in red and grey. The Aperto products can be combined individually from the range of accessories. We also offer two different sets.

▶ MORE DETAILS

#### Pesos Aperto Set A

Total weight: 18,5 kg

- 2x vinyl plates 1,25 kg
- 2x vinyl plates 2,5 kg
- 2x vinyl plates 5 kg
- 1x barbell 140 cm
- 2x spring locks

Set A Red	2050
Set A Grey	2050GR

▶ MORE DETAILS

#### Pesos Aperto Set B

Total weight: 9 kg

- 2x vinyl plates 0,5 kg
- 2x vinyl plates 1,25 kg
- 2x vinyl plates 2,5 kg
- 1x barbell 140 cm
- 2x spring locks

Set B Red	2051
Set B Grey	2051GR

#### Spring Locks

for Ø 2,8 cm barbell  
price per pair

Article	2058
---------	------



#### Barbell

140 cm / Ø 2,8 cm  
Weight: 1 Kg

Article	2057
---------	------



▶ MORE DETAILS

#### Rack

For 16 Pesos Aperto  
56 x 75 x 145 cm (L x W x H)  
Material: Steel, coated

Article	2060
---------	------



▶ MORE DETAILS

Also suitable: Premium Pump Set Rack Art. No. 2061





**New**  
now available  
up to  
40 Kg

▶ MORE DETAILS

**Hex Dumbbell**

1 Kg - 40 Kg  
Material: Chromed steel, Rubber

The high-quality hexagonal shaped dumbbells are available in 20 sizes from 1 kg to 40 kg and therefore offer the right weight for every training level.

Together with the ribbed chrome-plated handle, the Hex Dumbbell offers even more comfort and safety during training. The rubber coating already covers both the dumbbell and the floor.



Article	2081010	2081020	2081025	2081030	2081040	2081050	2081060	2081070
KG	1 kg	2 kg	2,5 kg	3 kg	4 kg	5 kg	6 kg	7 kg

Article	2081075	2081080	2081090	2081100	2081125	2081150	2081175	2081200
KG	7,5 kg	8 kg	9 kg	10 kg	12,5 kg	15 kg	17,5 kg	20 kg

Article	2081225	2081250	2081275	2081300	20813250	20813500	20813750	20814000
KG	22,5 kg	25 kg	27,5 kg	30 kg	32,5 kg	35 kg	37,5 kg	40 kg

▶ MORE DETAILS

**Dumbbell Pyramid**

For 10 pairs of dumbbells  
73 x 59 x 155 cm (L x W x H)  
Material: Steel, coated

With the help of the dumbbell rack you have an organized storage system and a high level of security suitable for ten pairs of dumbbells.

Available in silver grey and anthracite.

Colour	Article
Silvergrey	2090SG
Anthracite	2090A

**Now**  
also in  
anthracite  
available





▶ MORE DETAILS 

**Dumbbell Rack for 6 pairs of dumbbells**

150 x 40 x 80 cm (L x W x H)  
Material: Steel



Our new dumbbell storage system offers space for 6 pairs of dumbbells and can be expanded as required.

Article 2091A

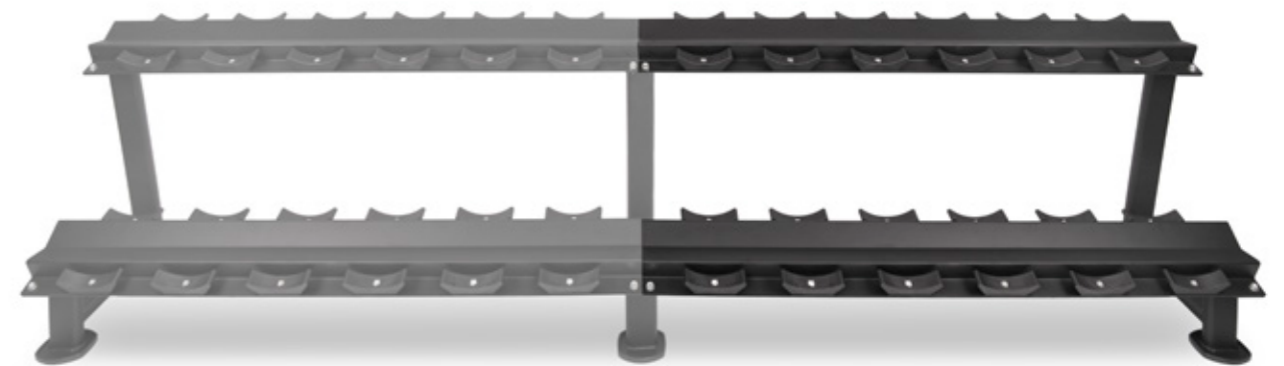

**Dumbbell Rack Extension**

150 x 40 x 80 cm (L x W x H)  
Material: Steel

We offer a suitable extension for our new dumbbell rack, which consists of two dumbbell supports for 6 pairs of dumbbells and a foot. The system can be extended as required.

Article 2991A



*two support parts can be connected to one stand part in the middle*



▶ MORE DETAILS 

### Dumbbell Pyramid

For 10 pairs of dumbbells  
73 x 59 x 155 cm (L x W x H)  
Material: steel, coated

With the help of the dumbbell rack, you have an orderly storage system and a high level of security. Fits ten pairs of chrome dumbbells.

Available in anthracite and silver grey

Colour	Article
Silvergrey	2090SG
Anthracite	2090A

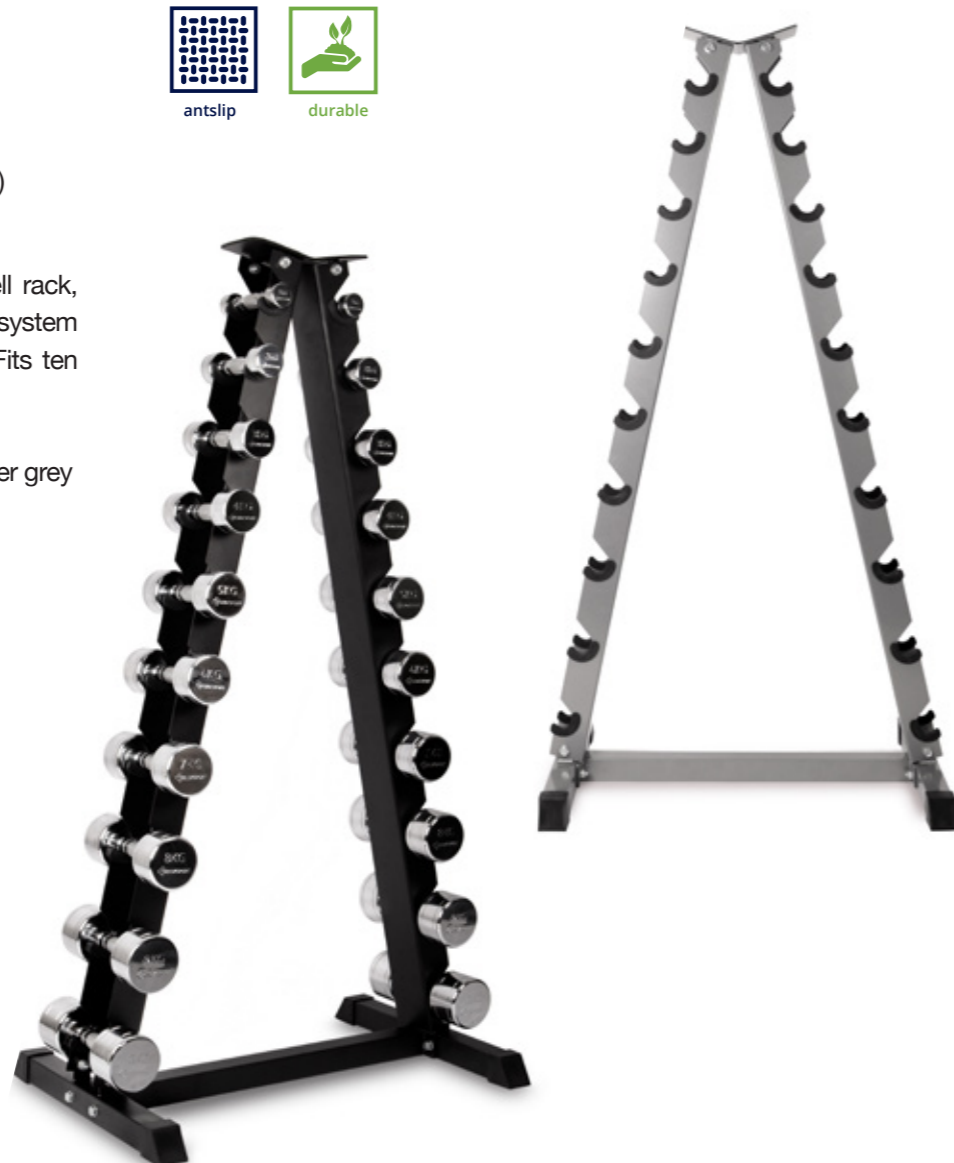

antislip



durable

▶ MORE DETAILS 

### Chrome Dumbbell Set

1 KG to 10 KG in pairs  
Material: Chromed steel

The dumbbells allow an enormous range of different exercises, whereby you can decide for yourself which muscle groups you want to train.

Thanks to the ergonomic, corrugated handle, the dumbbells are particularly comfortable to hold and are therefore extremely slip-proof, even when sweaty. The chrome dumbbells can easily be cleaned with water or disinfectant.

Dumbbell set  
1-10 Kg in pairs 2080



antislip



durable

Article	2070	2071	2072	2073	2074	2075	2076	2077	2078	2079
KG	1 kg	2 kg	3 kg	4 kg	5 kg	6 kg	7 kg	8 kg	9 kg	10 kg



▶ MORE DETAILS 



**Vinyl Dumbbell**

0,5 Kg - 5 Kg  
Material: Steel, Vinyl coated

The vinyl dumbbells are durable and water-repellent, vinyl-coated and lie comfortably in the hand. The hexagonal shape prevents it from rolling away and the vinyl coating ensures a firm grip and is odorless. Different weight classes enable an individual improvement in performance.



Article	2021	2022	2023	2024	2025	2026	2027
<b>KG</b>	0,5 kg	1 kg	1,5 kg	2 kg	3 kg	4 kg	5 kg
<b>Colour</b>	Orange	Green	Blue	Red	Purple	Black	Black

▶ MORE DETAILS 

**Suporte**

Rack for 60 vinyl dumbbells  
75 x 56 x 145 cm (L x W x H)  
Material: Steel, coated

The rack with different spacing can optimally accommodate any vinyl dumbbell size.

Article	2020SG
---------	--------







▶ MORE DETAILS



**Kettlebell Black**

4 Kg - 36 Kg  
Material: Cast iron chromed, steel, rubber

The Trendy Kettlebells Black are available from 4-36 kg. The chrome handle ensures a safe and secure grip, coded with rubber coating for safer using. With the Trendy Kettlebells Black you don't train just individual muscles, also groups of muscle areas throughout the body. Especially for the back and hip area.



chrome handle

Article	6404	6406	6408	6410	6412	6416
<b>KG</b>	4 kg	6 kg	8 kg	10 kg	12 kg	16 kg

Article	6420	6424	6428	6432	6436
<b>KG</b>	20 kg	24 kg	28 kg	32 kg	36 kg

A high-round fitness, stamina, coordination and body control speaks for the training with our Trendy Kettlebells Black.



▶ MORE DETAILS



**Kettlebell Rack**

120 x 52 x 75 cm (L x W x H)  
Fitting for all kettlebells

Article	6450
---------	------

▶ MORE DETAILS

**Kettlebell Vinyl**

4 Kg - 32 Kg  
Material: Cast iron, steel, vinyl

The Trendy Kettlebells Vinyl are available from 4-32 kg, colour-coded with vinyl coating.

Colour differences possible.



cast handle

Article	6504	6506	6508	6510	6512	6516	6520	6524	6528	6532
<b>KG</b>	4 kg	6 kg	8 kg	10 kg	12 kg	16 kg	20 kg	24 kg	28 kg	32 kg
<b>Colour</b>	Yellow	Yellow	Red	Violet	Red	Light Blue	Purple	Blue	Grey	Black

**New**  
now available



▶ MORE DETAILS

**Premium Esfera Ball**

Ø 19 / 23 / 29 cm  
Material: Rubber

With the help of the Esfera Medicine Ball, you have a wide range of possible uses. The Esfera Medicine Ball is equipped with a needle valve, which ensures that you can regulate the air yourself. This enables an individual adjustment of the jumping power.

Due to its pimpled surface structure, it is particularly easy to grip, very hard-wearing and extremely durable. It is easy to wash off, which ensures a high level of hygiene. The different colours indicate different weight levels.

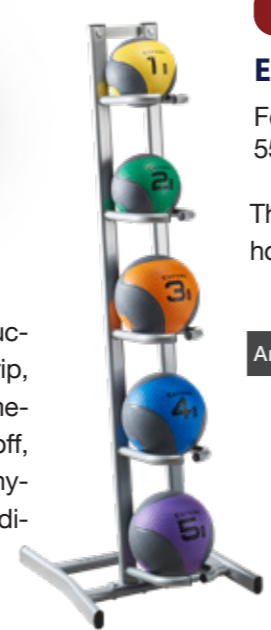

▶ MORE DETAILS

**Esfera Rack**

For 5 Trendy Esfera Balls  
550 x 57 x 154 cm (L x W x H)

The stable Esfera rack can hold up to five esfera balls.

Article	6211
---------	------

▶ MORE DETAILS

**Esfera Slam Ball**

Ø 24 cm (1-10 Kg), Ø 29 cm (12-20 Kg)  
Material: PVC, sand

Our new Esfera Slam Ball with a very low rebound is ideal for slams and throws, with which you can optimally train strength endurance and coordination.

Due to its structure, the Slam Ball offers a very good grip during training and prevents it from rolling away. The ball is available from 4-20 kg.



▶ MORE DETAILS

**Esfera Rack**

For 5 Trendy Esfera Balls  
50 x 57 x 154 cm (L x W x H)

The stable Esfera rack can hold up to five esfera balls.



Article	6211
---------	------

Article	6601	6602	6603	6604	6605	6606	6607	6608	6609	6610
<b>KG</b>	1 kg	2 kg	3 kg	4 kg	5 kg	6 kg	7 kg	8 kg	9 kg	10 kg
<b>Size</b>	Ø 19 cm	Ø 19 cm	Ø 23 cm	Ø 23 cm	Ø 23 cm	Ø 29 cm	Ø 29 cm	Ø 29 cm	Ø 29 cm	Ø 29 cm
<b>Colour</b>	Yellow	Green	Orange	Blue	Purple	Yellow	Green	Orange	Blue	Purple

Article	6704	6705	6706	6707	6708	6709	6710	6712	6715	6718	6720
<b>KG</b>	4 kg	5 kg	6 kg	7 kg	8 kg	9 kg	10 kg	12 kg	15 kg	18 kg	20 kg
<b>Size</b>	Ø 24 cm	Ø 24 cm	Ø 24 cm	Ø 24 cm	Ø 24 cm	Ø 24 cm	Ø 24 cm	Ø 29 cm	Ø 29 cm	Ø 29 cm	Ø 29 cm



▶ MORE DETAILS

**Trendy Esfera Bag**

Length 55 cm / Ø 24 cm  
Material: PVC  
Filling: Sand

The Esfera weight bag appeals to many muscle groups and can therefore be used in a variety of ways. The many handles and loops enable numerous training units. With the help of the self-selectable weight levels, an intensive training can be individually adapted to your own physical performance. The special thing about the Trendy Esfera Bags is that the sandbags they contain are not

with 5 handles

sewn, but glued, which makes them burst-proof. The sandbags can be easily exchanged via a zip opening. The different colours indicate different weight levels.



- antibacterial protection
- durable
- recyclable
- 6P FREE

Artikel	5051-05	5051-10	5051-15	5051-20	5051-25	5051-30
<b>KG</b>	5 kg	10 kg	15 kg	20 kg	25 kg	30 kg
<b>Colour</b>	Yellow	Green	Blue	Orange	Red	Grey

▶ MORE DETAILS

**Trendy Esfera Rack**

57 x 69 x 141 cm (L x W x H)  
Material: Steel, coated

With the Esfera Bag Rack you can store your Trendy Esfera Bags neatly, space-saving and above all safely. For a maximum of five trendy Esfera Bags.

Article 5051





▶ MORE DETAILS

### Weight Cuffs

0,5 Kg - 3 Kg  
Material: Nylon jersey  
Filling: Sand



With our new hand and foot weights in six weight levels, you can effectively intensify your training by increasing the load. The velcro fastener ensures a secure hold and stability during training and is quickly adjustable. The weight cuffs are suitable for training in fitness, therapy and rehabilitation.

Our polyester product is easy to care for and has a high quality finish, is sewn twice and filled with sand. Convince yourself of the durability and quality of our weight cuffs!

Incl. sales packaging.

Article	2041	2042	2043	2044	2045	2046
KG	0,5 Kg	1 Kg	1,5 Kg	2 Kg	2,5 Kg	3 Kg

# FLOORING MATS



PLEASE CLICK DIRECTLY TO THE PRODUCT!

Segura Rubber flooring .....	170
Segura Rubber flooring color .....	174
Segura Absorption .....	178
Cardio Flooring Fundamento .....	180
<b>NEW</b> Sprint track .....	182
<b>NEW</b> StudioLine Classico & Madeira .....	184
Double Competition Standard .....	186
Double Competition Profi .....	187
Double Competition Judo .....	188

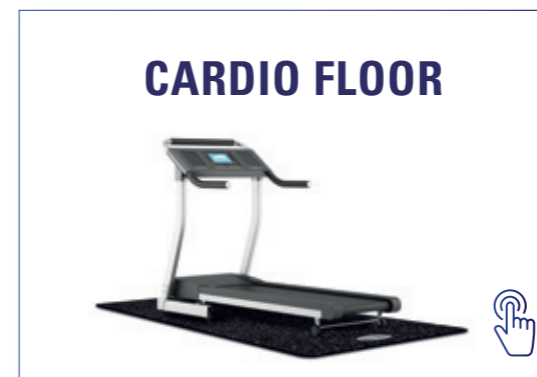
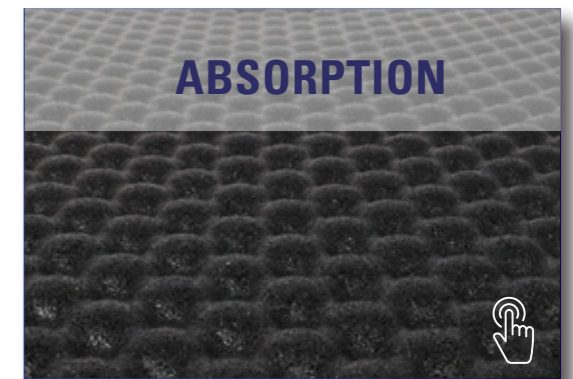



**NOW**  
improved  
quality!  
100%  
recycled  
rubber

-  antislip
-  extremely good absorption
-  very good acoustic insulation
-  durable
-  sustainable production

1000 kg/m<sup>3</sup>

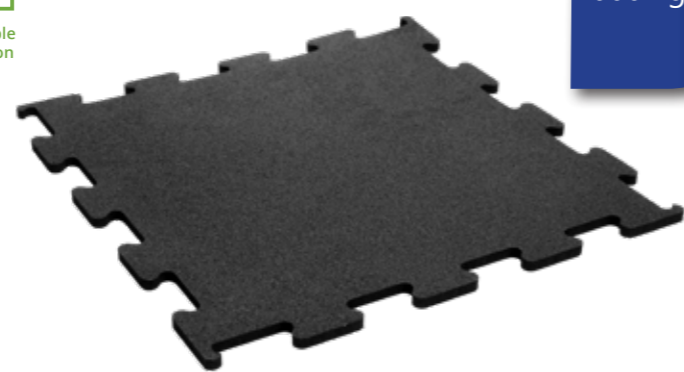

▶ MORE DETAILS 

### Rubber Flooring Segura Interlocking

100 x 100 cm | 1 m<sup>2</sup>  
Density: 1000 kg/m<sup>3</sup>  
Material: 100% recycled rubber

With our Rubber Flooring Segura system, we offer you high-quality floor mats in five different thicknesses for your fitness and weight areas and thus maximum safety during training, effective noise reduction and optimal protection of your floor.

With a density of 1000 kg/m<sup>3</sup>, our mats are extremely hard-wearing and are particularly suitable for equipping professional fitness and weight training areas. Thanks to the tooth system, the mats can easily be laid loosely and do not slip due to their high weight and surface adhesion.

Segura Int.	18010A	18015A	18020A
<b>Thickness</b>	1 cm	1,5 cm	2 cm
<b>Delivery time</b>	<b>in stock</b>	<b>in stock</b>	3 weeks
<b>Min. quantity</b>	<b>1 pcs.</b>	<b>1 pcs.</b>	50 pcs.

The 100 x 100 cm mats can be individually adapted to your room conditions and with their high abrasion resistance they are the perfect choice for use in fitness studios, playgrounds, kindergartens and much more. Tripping edges

are avoided by the bevelled edge and corner strips and therefore offer additional safety and comfort. Create the right foundation for your fitness area now, because the premium material is tailored to the needs of your customers

### Segura Interlocking Border & Corner

100 x 100 cm | 1 m<sup>2</sup>

We offer suitable end mats with a bevelled edge for the edging and corner edging. In addition to an elegant look, this also offers an additional safety aspect.

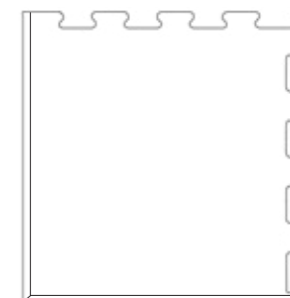
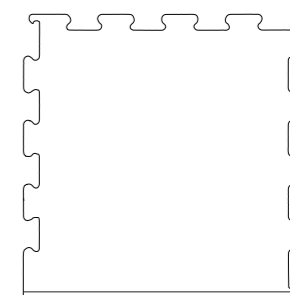





Segura Rand Int.	18110A	18115A	18120A
Segura Ecke Int.	18210A	18215A	18220A
<b>Thickness</b>	1 cm	1,5 cm	2 cm
<b>Delivery time</b>	<b>in stock</b>	<b>in stock</b>	3 weeks
<b>Min. quantity</b>	<b>1 pcs.</b>	<b>1 pcs.</b>	50 pcs.



**NOW**  
improved  
quality!



-  antislip
-  extremely good absorption
-  very good acoustic insulation
-  durable
-  sustainable production

100%  
recycled  
rubber

1000 kg/m<sup>3</sup>

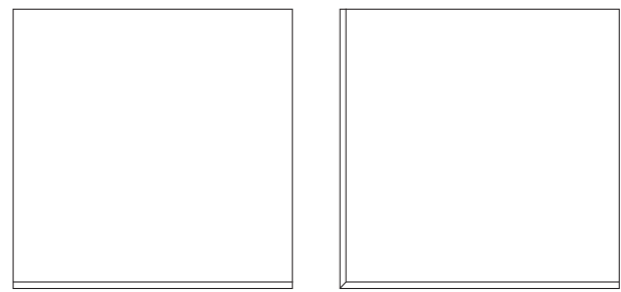
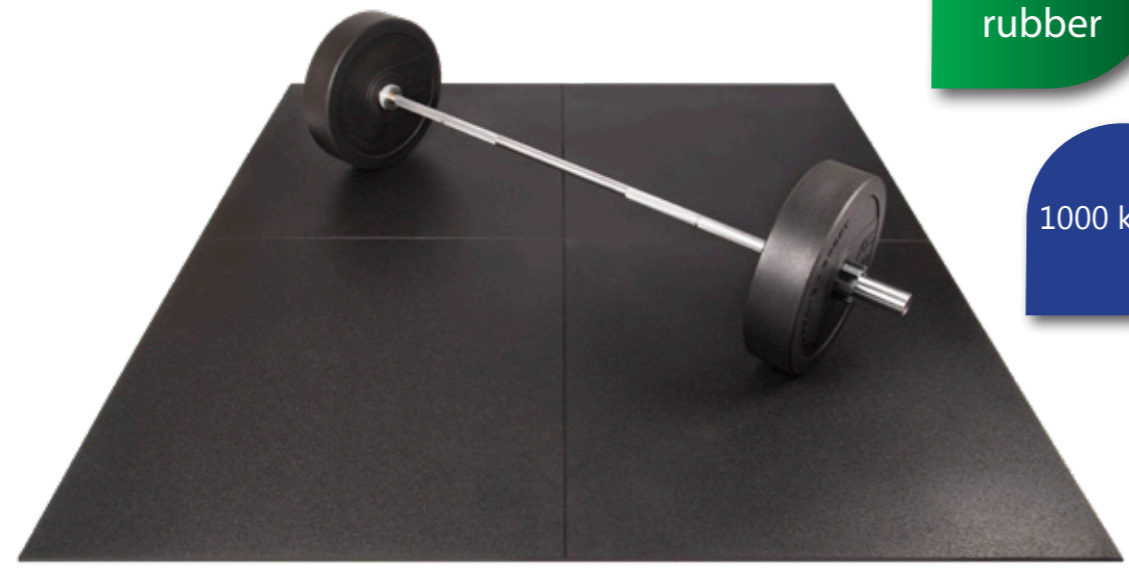

**Segura Border & Corner**

100 x 100 cm | 1 m<sup>2</sup>  
Density: 1000 kg/m<sup>3</sup>  
Material: 100% recycled rubber

We offer suitable end mats with a bevelled edge for boarder and corner mats. In addition to an elegant look, this also offers an additional safety aspect.

Segura Rand	17110A	17115A	17120A
Segura Ecke	17210A	17215A	17220A
<b>Thickness</b>	1 cm	1,5 cm	2 cm
<b>Delivery time</b>	<b>in stock</b>	<b>in stock</b>	3 weeks
<b>Min. quantity</b>	<b>1 pcs.</b>	<b>1 pcs.</b>	50 pcs.

▶ MORE DETAILS 

**Rubber Flooring Segura**

100 x 100 cm | 1 m<sup>2</sup>  
Density: 1000 kg/m<sup>3</sup>  
Material: 100% recycled rubber





The Rubber Flooring Segura system with straight edges has an even simpler look and blends in perfectly with the environment for various purposes.

Segura	17010A	17015A	17020A
<b>Thickness</b>	1 cm	1,5 cm	2 cm
<b>Delivery time</b>	<b>in stock</b>	<b>in stock</b>	3 weeks
<b>Min. quantity</b>	<b>1 pcs.</b>	<b>1 pcs.</b>	50 pcs.

<p><b>Application area</b></p> <ul style="list-style-type: none"> <li>• gyms</li> <li>• cardio area</li> <li>• dumbbell area</li> <li>• aerobic area</li> <li>• practice and therapy rooms</li> <li>• playgrounds</li> <li>• kindergartens</li> </ul>	<p><b>Product characteristics</b></p> <ul style="list-style-type: none"> <li>• material: 100% rubber granulate</li> <li>• density: 1000 kg/m<sup>3</sup></li> <li>• sustainability - 100% recycled material</li> <li>• high abrasion resistance</li> <li>• antislip property</li> <li>• very good sound insulation</li> <li>• easy installation and cleaning</li> </ul>
---	---



**NOW**  
improved  
quality!

-  antislip
-  extremely good absorption
-  very good acoustic insulation
-  durable
-  sustainable production

100%  
recycled  
rubber



**Color options**

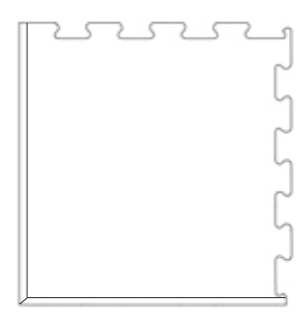
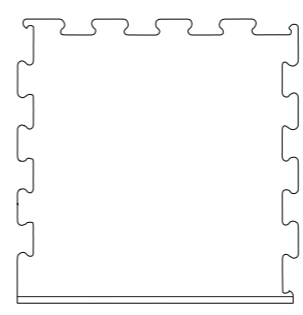
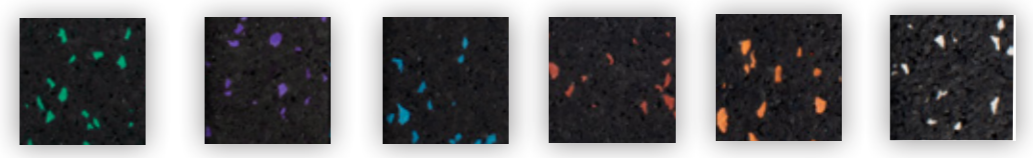

**Segura Colour Interlocking Border**

100 x 100 cm | 1 m<sup>2</sup>

Colour/Thickness	1 cm	1,5 cm	2 cm
White	18110W	18115W	18120W
Blue	18110B	18115B	18120B
Red	18110R	18115R	18120R
Green	18110G	18115G	18120G
Purple	18110P	18115P	18120P
Yellow	18110Y	18115Y	18120Y
Orange	18110OR	18115OR	18120OR

**Segura Colour Interlocking Corner**

100 x 100 cm | 1 m<sup>2</sup>

Colour/Thickness	1 cm	1,5 cm	2 cm
White	18210W	18215W	18220W
Blue	18210B	18215B	18220B
Red	18210R	18215R	18220R
Green	18210G	18215G	18220G
Purple	18210P	18215P	18220P
Yellow	18210Y	18215Y	18220Y
Orange	18210OR	18215OR	18220OR

**Segura Colour Interlocking**

100 x 100 cm | 1 m<sup>2</sup>

You can also order our Segura interlocking mats with 10% colored EPDM. We offer these in 6 colors as standard, other colors on request.





Colored mats can be delivered in 2-3 weeks from a minimum order quantity of 50 pieces. Thickness up to max. 5 cm available.

Colour/Thickness	1 cm	1,5 cm	2 cm
White	18010W	18015W	18020W
Blue	18010B	18015B	18020B
Red	18010R	18015R	18020R
Green	18010G	18015G	18020G
Purple	18010P	18015P	18020P
Yellow	18010Y	18015Y	18020Y
Orange	18010OR	18015OR	18020OR





**NOW**  
improved  
quality!

-  antislip
-  extremely good absorption
-  very good acoustic insulation
-  durable
-  sustainable production

**Segura Colour**

100 x 100 cm | 1 m<sup>2</sup>

You can also order our Segura mats with 10% colored EPDM. We offer these in 6 colors as standard, other colors on request.

Colored mats can be delivered in 2-3 weeks from a minimum order quantity of 50 pieces. Thickness up to max. 5 cm available.

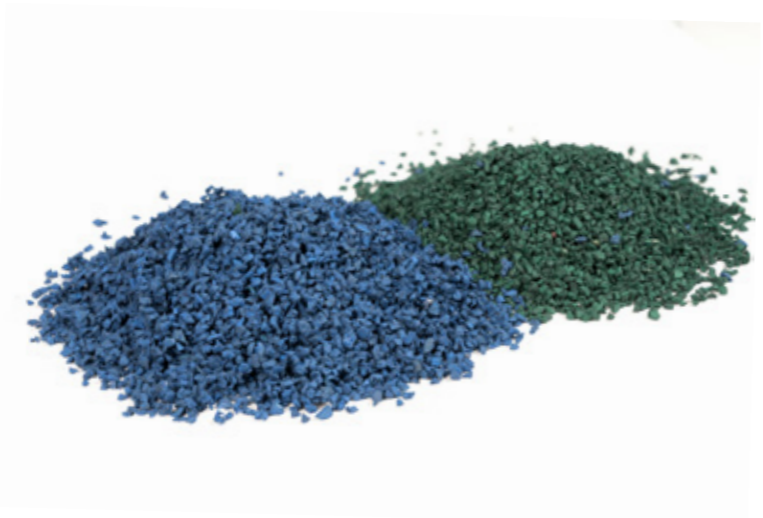

Colour/Thickness	1 cm	1,5 cm	2 cm
White	17010W	17015W	17020W
Blue	17010B	17015B	17020B
Red	17010R	17015R	17020R
Green	17010G	17015G	17020G
Purple	17010P	17015P	17020P
Yellow	17010Y	17015Y	17020Y
Orange	17010OR	17015OR	17020OR

**Color options**

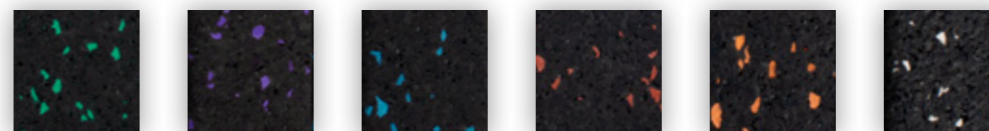

1000 kg/m<sup>3</sup>

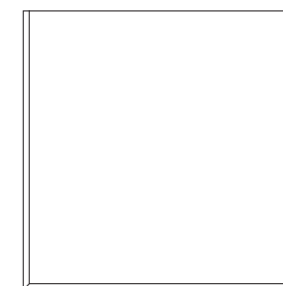
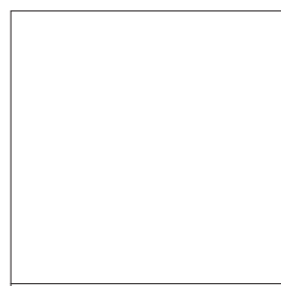

**Segura Colour Border**

100 x 100 cm | 1 m<sup>2</sup>

Colour/Thickness	1 cm	1,5 cm	2 cm
White	17110W	17115W	17120W
Blue	17110B	17115B	17120B
Red	17110R	17115R	17120R
Green	17110G	17115G	17120G
Purple	17110P	17115P	17120P
Yellow	17110Y	17115Y	17120Y
Orange	17110OR	17115OR	17120OR





**Segura Colour Corner**

100 x 100 cm | 1 m<sup>2</sup>

Colour/Thickness	1 cm	1,5 cm	2 cm
White	17210W	17215W	17220W
Blue	17210B	17215B	17220B
Red	17210R	17215R	17220R
Green	17210G	17215G	17220G
Purple	17210P	17215P	17220P
Yellow	17210Y	17215Y	17220Y
Orange	17210OR	17215OR	17220OR



**NEW**  
now available

-  antislip
-  extremely good absorption
-  very good acoustic insulation
-  durable
-  sustainable production

▶ MORE DETAILS 

### Rubber Flooring Segura Absorption

100 x 100 x 2/3 cm  
Density: 1000 kg/m<sup>3</sup>  
Material: 100% recycled rubber

The new Segura Absorption rubber floor mats offer even better sound and step insulation thanks to their curved structure on the underside and are therefore not only suitable for the heavy weight area, but also for many other areas such as Outdoor, horse stables, garages, etc.

Article	22020A	22025A	22030A	22040A
Thickness	2 cm	2,5 cm	3 cm	4 cm

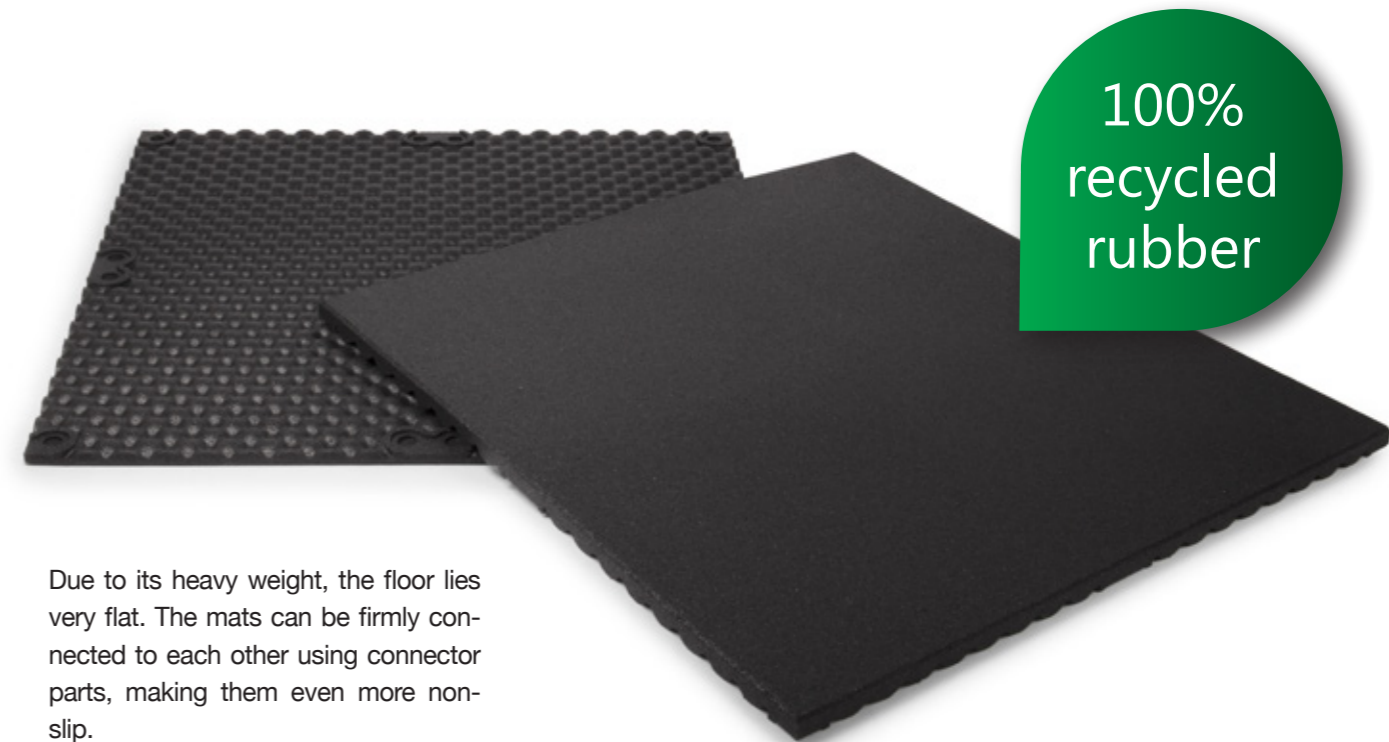

Due to its heavy weight, the floor lies very flat. The mats can be firmly connected to each other using connector parts, making them even more non-slip.



The mats are available in thicknesses of 2 cm and 3 cm. Available for delivery in 2-3 weeks with a minimum order quantity of 50 pieces.



▶ MORE DETAILS 

**Rubber Flooring Fundamento**





100 x 200 x 0,4 cm  
 Weight: 8,2 Kg  
 Material: 100% recycled rubber

With a thickness of 4 mm, the rubber floor Fundamento is the perfect floor covering for various cardio devices such as indoor bikes, cross trainers, steppers and much more. It offers excellent floor protection and is also extremely non-slip. Shock and sound absorbing properties ensure a comfortable and joint-gentle workout.

With the handy dimensions of 100 x 200 cm, the floor fits under any standard cardio machine. If necessary, several mats can be placed directly next to each other, so that the floor can be expanded as desired.

Colour	Art. No.
Anthracite	16001A
Anthracite-White	16001W



-   
antislip
-   
extremely good absorption
-   
very good acoustic insulation
-   
durable
-   
sustainable production





▶ MORE DETAILS 

**Sprinttrack**

1200 x 200 cm  
 Thickness 1,5 cm  
 63.000 Knots / m<sup>2</sup>

Our new Sprint Track lawn mat impresses with its particularly high material density and strength and is therefore particularly abrasion-resistant and durable. The Sprint Track can be used to perform speed exercises, for example with a weight sled. The floor is available in anthracite or green.

**NEW**  
 now  
 available

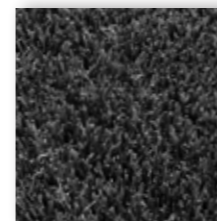
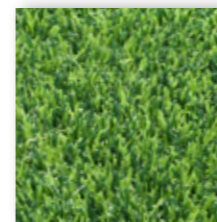

Colour	Art. No.
Anthracite	21122A
Green	21122G

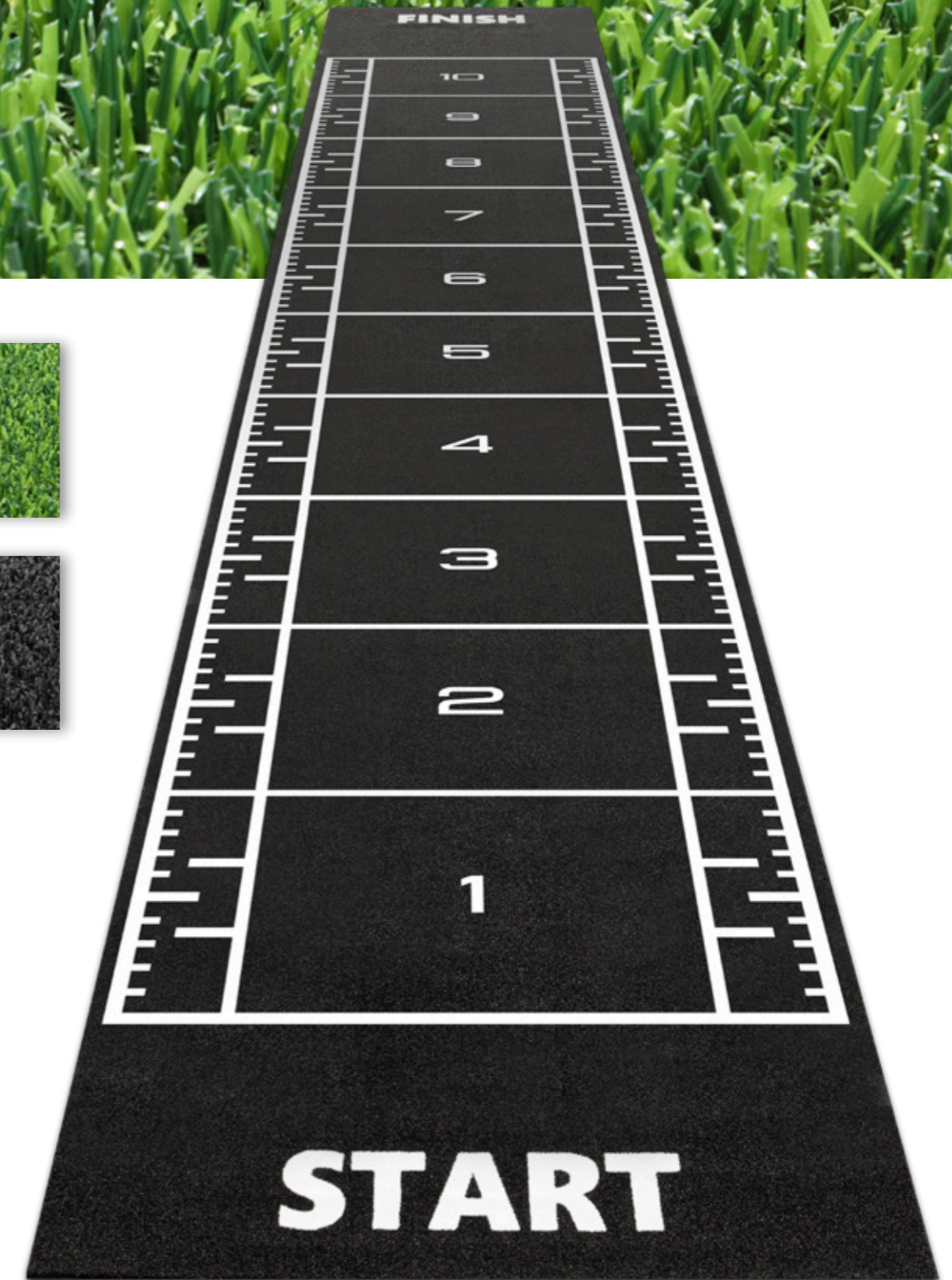

**NEW**

now even more solid quality

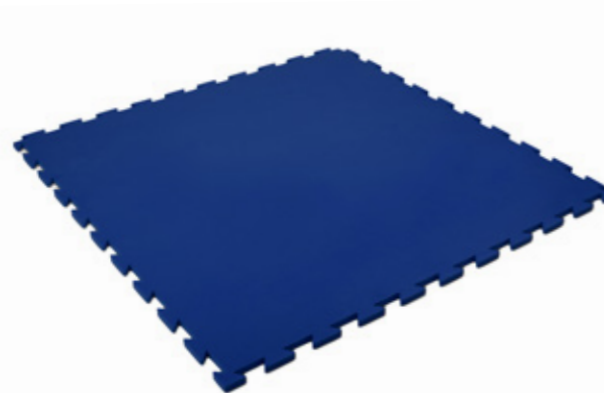
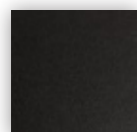
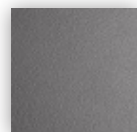

Colour	Art. No.
Grey	8500HG
Anthracite	8500A
Blue	8500B



Inclusive four edge pieces

▶ MORE DETAILS

**StudioLine Classico**

100 x 100 x 1,4 cm (± 0,5 mm)  
 Hardness 60° – 65°  
 Material: EVA

The point-elastic and joint-friendly StudioLine Classico flooring is extremely resistant even under heavy use and is therefore perfectly suitable for fitness studios, therapy rooms and in the aerobic area. The floor covering reduces the development of noise and therefore creates a pleasant acoustic feeling of space.

Laying even without instructions is extremely easy and can be done directly on any substrate without costly preparation. The antibacterial floor is also easy to clean with water. StudioLine Classico offers a color selection between four different colors and thus offers interesting combination options to individually upgrade your fitness area!

Colour differences possible, height differences of 0,5 mm possible.

▶ MORE DETAILS

**StudioLine Madeira**

100 x 100 x 1,4 cm (± 0,5 mm)  
 Hardness 60° – 65°  
 Material: EVA

StudioLine Madeira is the resistant floor covering for high demands in fitness studios and therapy rooms. The point-elastic and joint-friendly StudioLine Madeira floor remains dimensionally stable even under heavy use and is ideal for aerobics and therapy.

It is extremely easy to lay without instructions and can be carried out directly on any surface without costly preparation. StudioLine Madeira enhances every fitness area with its elegant wood look!

Colour differences possible, height differences of 0,5 mm possible.

**Product characteristics**

- high quality
- maximum comfort
- point elastic
- anti-germ
- noise reducing
- easy to clean without detergents

closed cell structure	antibacterial protection	light weight	extremely good absorption	very good acoustic insulation	durable



Article 8500HW



Inclusive four edge pieces



OFFICIAL COMPETITION MAT OF THE GERMAN BUDD ASSOCIATION AND THE HKBV (WAKO MEMBER) - RECOMMENDED BY WAKO PER GERMANY

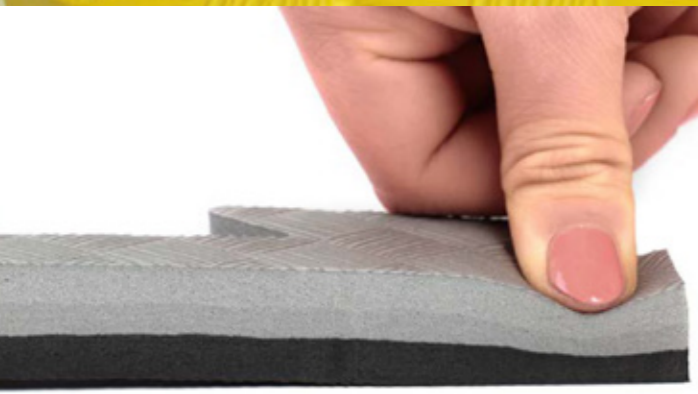

extra hard!

▶ MORE DETAILS

**Double Competition Standard**

100 x 100 x 2 cm (± 1,0 mm)  
Hardness 35° – 40°  
Material: EVA

Qualified for many sports, already proven in martial arts such as karate, taekwondo and kickboxing. Our Double Competition can be laid floating. Front and rear side can be used on both sides (turn-around-floormat). The interlocking-

system fixes the mats together. There is no limit for individual room design, whether in color or through integrated edge-band.

Colour differences possible, height differences of 1 mm possible.

Colour	Art. No.
Grey/Anthracite	1123SG
Blue/Red	1123BR
Green/Yellow	1123GY

- closed cell structure
- antibacterial protection
- light weight
- extremely good absorption
- very good acoustic insulation
- durable

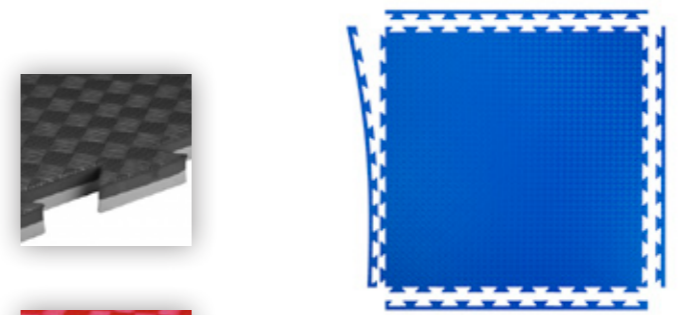

All sportmats inclusive four edge pieces

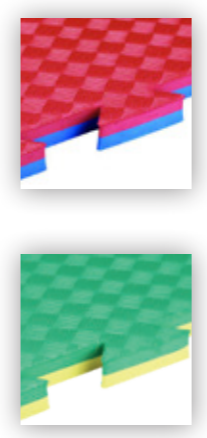

Colour	Art. No.
Grey/Anthracite	3123SG
Blue/Red	3123BR
Green/Yellow	3123GY

▶ MORE DETAILS

**Double Competition Profi**

100 x 100 x 2 cm (± 1,0 mm)  
EN 1177 Impact Absorbing 90 cm  
Hardness 50° – 55°  
Material: EVA

The Double Competition Profi is even more resistant and better shock-absorbing properties. The mat meets the highest standards and is recommended by martial arts associations and used for competitions.

Colour differences possible, height differences of 1 mm possible.

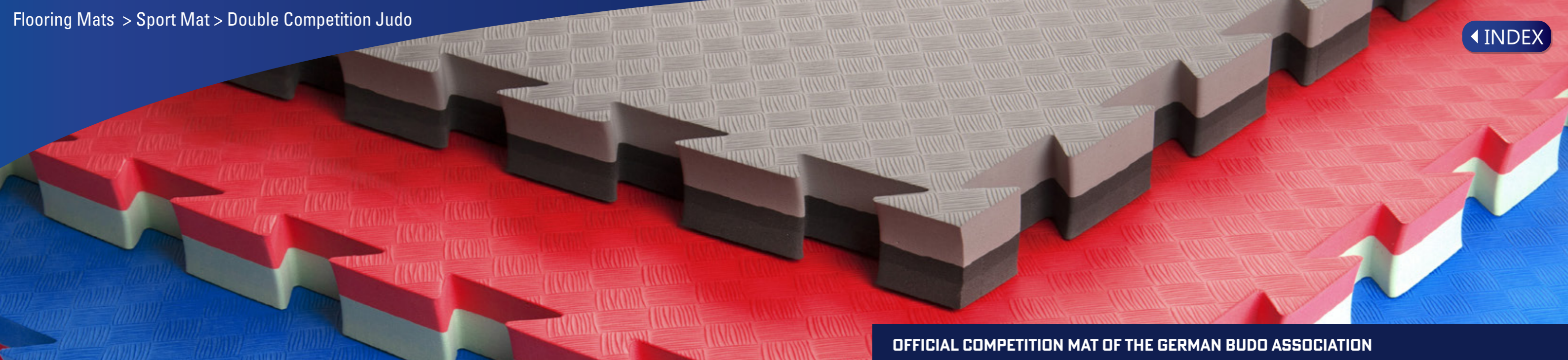

OFFICIAL COMPETITION MAT OF THE GERMAN BUDO ASSOCIATION

▶ MORE DETAILS

4 cm thick!

**Double Competition Judo**  
 100 x 100 x 4 cm (± 1,5 mm)  
 EN 1177 Impact absorbing 160 cm  
 Hardness 30° – 35°  
 Material: EVA

Qualified for many sports, already proven in material arts such as karate, taekwondo and kickboxing. Our Double Competition can be laid loosely. Front and rear side can be used on both sides (turnaround-floor mat). The interlocking-system fixes the mats together. There is no limit for individual room design, whether in colour or through integrated edge-band.

Colour differences possible, height differences of 1 mm possible.

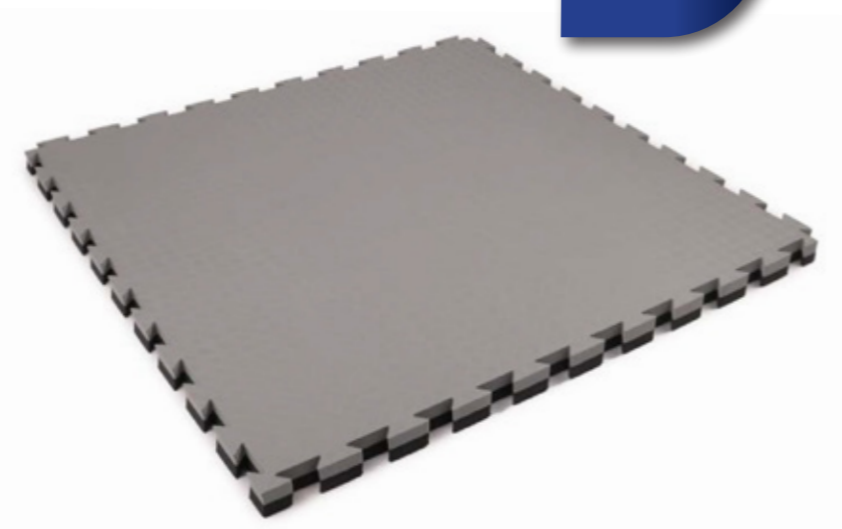

Colour	Art. No.
Grey/Anthracite	4123SG
Blue/Red	4123BR
Green/Red	4123GR



All sportmats inclusive four edge pieces

- closed cell structure
- antibacterial protection
- light weight
- extremely good absorption
- very good acoustic insulation
- durable

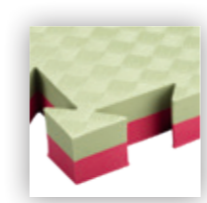
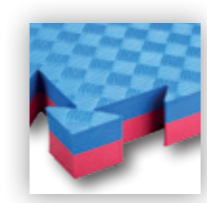
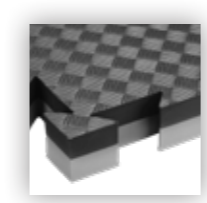

**Did you know?**  
 The Double Judo Competition is the **official competition mat** of the German Budo Association and stands for professionalism and quality.



PLEASE CLICK DIRECTLY  
TO THE PRODUCT!

# RFID- PRODUCTS

- RFID Wristband ..... 192
- RFID Wristband Clever Fit ..... 194
- RFID Cards ..... 196
- RFID Tags ..... 197







▶ MORE DETAILS 



**RFID Wristband Acceso**

Diameter: 6/6,5 cm  
Material: silicone

**Now NEW in our program:**

in different designs and colors practical **key wristbands made of skin-friendly silicone.**

You can choose between the models:

- 3 designs: straight, round, oval
- 2 sizes: 6 cm, 6,5 cm
- 6 colours
- Chip Mifare compatible
- Frequency 13.56MHz
- Skin-friendly silicone

**Design 1 - straight**



Colour	Grey	Orange	Red	Blue	Green	Anthracite
<b>Design 1 straight</b>	67020GR	67020OR	67020R	67020B	67020G	67020A
<b>Design 2 round</b>	67021GR	67021OR	67021R	67021B	67021G	67021A
<b>Design 3 oval</b>	67022GR	67022OR	67022R	67022B	67022G	67022A

Quantity	500* - 999	ab 1.000	ab 3.000	ab 5.000	ab 10.000
----------	------------	----------	----------	----------	-----------

**\*Minimum order 500 pieces per design, size, color, chip and individualization**

We can customize the straps with your logo.

You have the choice between:

- 1 colour print
- 2 colour print
- 1 colour print with engraving
- 2 colour print with engraving

Feel free to contact us and let us advise you!

**Printing area:**  
**Design 1 - straight: 6 x 1,5 cm**  
**Design 2 - round: Ø 2,5 cm**  
**Design 3 - oval: Ø 2 cm**



**\*After approval for printing, we will deliver your order to you worldwide within 30 days for a surcharge of 175 € / 1000 pieces.**



*Example for 1c-print*



*Example for engraving with 2c-print*

Individualization	1c print	2c print	1c print incl. engraving	2c print incl. engraving
Art. No.	67LOGO1C	67LOGO2C	67LOGO1CGR	67LOGO2CGR



# clever fit

**New**  
incl. Gantner-  
Coding



### RFID wristband CleverFit

Diameter: 6/6,5 cm  
Color: red or black  
Material: silicone

We offer you printed and engraved CleverFit chip bands including chip and Gantner coding. We offer red or black color versions as shown in 60 cm or 6,5 cm diameter.

- 2 colors: red/black
- 2 sizes: 6 cm, 6,5 cm
- Chip Mifare compatible
- Frequency 13,56 MHz
- Gantner Coding
- Skin-friendly silicone

Colour	Diameter	Art. No.
Red	Ø 6 cm	67020R60CLG
Red	Ø 6,5 cm	67020R65CLG
Anthracite	Ø 6 cm	67020A60CLG
Anthracite	Ø 6,5 cm	67020A65CLG





▶ MORE DETAILS

**RFID Card Acceso**

Art. No. 67025  
Size: 8,5 x 5,4 x 0,08 cm  
Material: Plastic

Now **NEW** in our program:  
practical key cards made of durable plastic including 4c printing

- Glossy or mat finish
- Chip Mifare compatible
- Frequency 13.56MHz
- Individually printable



\*After approval for printing, we will deliver your order to you worldwide within 30 days for a surcharge of 175 € / 1000 pieces.



Design example

Quantity	from 1.000	from 2.000	from 3.000	from 5.000	from 10.000
----------	------------	------------	------------	------------	-------------

\*Minimum order 1000 pieces per chip and individualization

▶ MORE DETAILS

**RFID Tag Acceso**

Art. No. 67026  
Size: 4,5 x 3 x 0,4 cm  
Material: Plastic, Epoxy

Now **NEW** in our program:  
practical key tag made of durable epoxy resin including 4c printing

- Chip Mifare compatible
- Frequency 13,56 MHz
- Individually printable



\*After approval for printing, we will deliver your order to you worldwide within 30 days for a surcharge of 175 € / 1000 pieces.



Design example

Quantity	from 1.000	from 2.000	from 3.000	from 5.000	from 10.000
----------	------------	------------	------------	------------	-------------

\*Minimum order 1000 pieces per design, chip and individualization



Trendy Sport GmbH & Co. KG  
Am Erberslohe 15-17  
D - 91154 Roth

Tel +49 9171 9756-30  
Fax+49 9171 9756-35  
sale@trendy-sport.com  
[www.trendy-sport.eu](http://www.trendy-sport.eu)

